



European Import Group

**2019**

**Products catalogue**

Catalogue de produits  
Catálogo de productos  
Catálogo de produtos



www.eig.pt

EIG - Catálogo de Produtos 2019  
Edição 01/2019

☎ 220 994 447  
info@eig.pt  
www.eig.pt

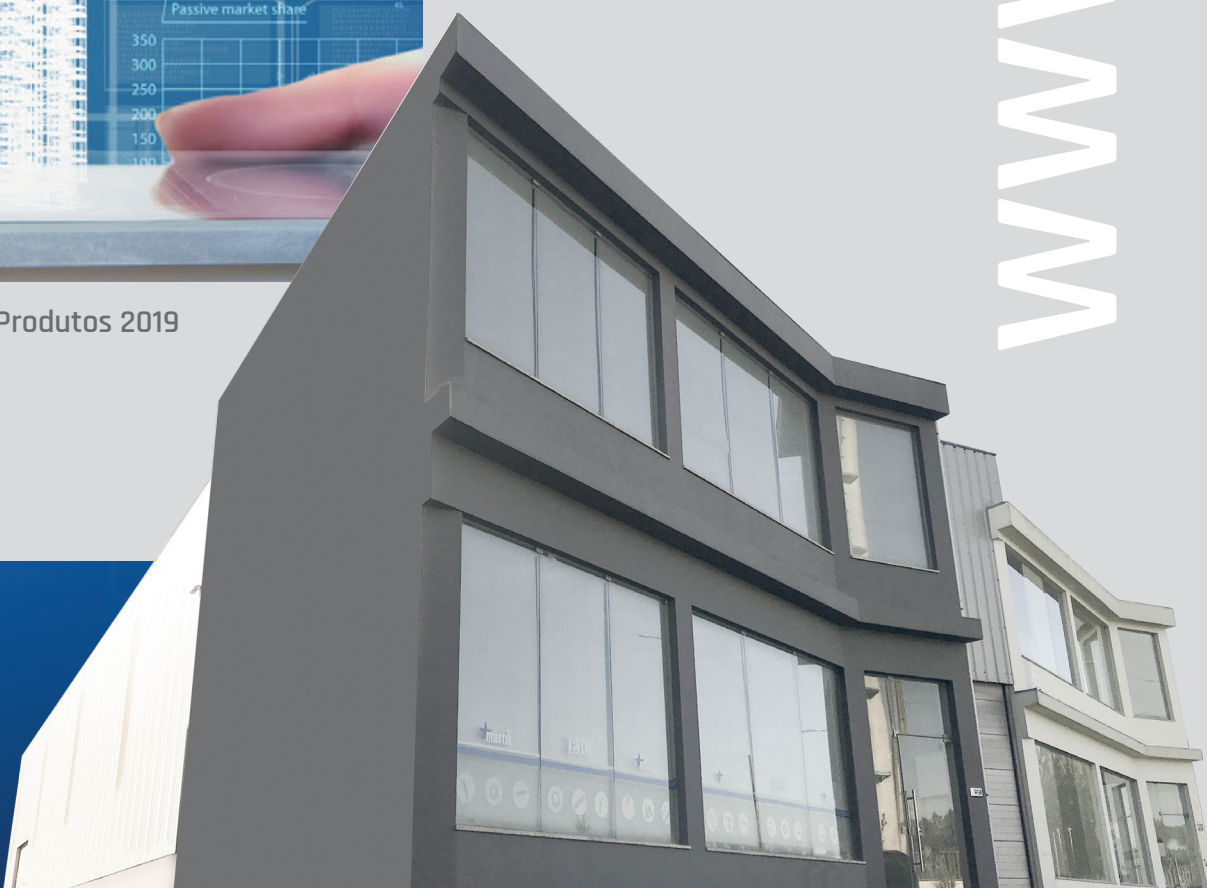



Caro Cliente,

É com prazer que apresentamos o novo catálogo EIG 2019, no qual incorporamos uma vasta gama de parafusos, buchas metálicas normais e homologadas, buchas de nylon, anilhas, rebites, porcas, varões e suportes de ligação.

Reconhecemos a máxima importância e exigência dos materiais de qualidade nas construções da atualidade, onde trabalhamos arduamente para estar na linha dos objetivos dos grandes construtores.

### MISSÃO

A missão da EIG é ser um grande fornecedor industrial, assegurando aos seus clientes uma vasta gama de produtos de excelente qualidade. Estar em constante crescimento. Ser gerador de criatividade, inovação, e dinamismo, com presença internacional. Com uma crescente rentabilidade, possibilitando aos seus colaboradores o desenvolvimento pessoal e profissional.

### VISÃO

Pretendemos o reconhecimento da EIG no sector do fornecimento industrial tanto a nível nacional como internacional como sendo:

- Rentável e competitiva.
- Líder de mercado a nível nacional e uma referência a nível internacional
- Impulsionador de novas gamas de produtos em sectores contíguos à nossa atividade.
- Provedor de soluções globais à medida dos nossos clientes, desde a flexibilidade ao dinamismo.
- Um grupo com um claro critério de melhoria contínua nos seus processos e comprometido com o desenvolvimento e formação dos seus colaboradores.



Pedro H. Matos  
Diretor geral

# ÍNDICE

PAG.

			CONCRETE BETON HORMIGÓN BETÃO	REINFORCED CONCRETE BETON ARMADO BETÃO ARMADO	STONE PIERRE PIEDRA PEDRA	CRACKED CONCRETE BETON FISURADO HORMIGÓN FISURADO BETÃO FISURADO	SOLID BRICK BRIQUE PELE LADRILLO MACIZO TIJOLO MACIÇO	AERATED CONCRETE BLOQUE ALULIBRE HORMIGÓN ALIGERO BETÃO LIGERO	HOLLOW BRICK BRIQUE CREUSE LADRILLO HUECO TIJOLO OCO	CONCRETE HOLLOW BLOCK BETON CREUSE HORMIGÓN HUECO BLOCO DE BETÃO OCO
18		MTA								
19		MTA INOX A2								
19		A4-MTA INOX A4								
20		MTA-HOM OP7								
21		MTA PLUS OP1								
22		BCHP								
22		BCHO								
22		BCHG								
23		BCHP INOX A2+A4								
23		BCHP 8.8								
24		HVE								
24		HVE-02								
25		BT								
25		BTF								
26		THCH								
26		THCH+ TARNE								
27		THCP								
27		THCC								
27		TPTH								

# ÍNDICE



















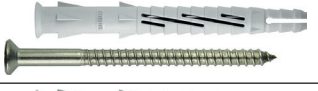







								PAG.
<b>CONCRETE</b> BETON HORMIGÓN BETÃO	<b>REINFORCED CONCRETE</b> BETON ARMÉ HORMIGÓN ARMADO BETÃO ARMADO	<b>STONE</b> PIERRE PIEDRA PEDRA	<b>PLASTERBOARD</b> PLAQUES DE PLÂTRE PANEL YESO LAMINADO PLACA DE GESSO	<b>SOLID BRICK</b> Brique Pleno LADRILLO MACIZO TIJOLO MACIÇO	<b>AERATED CONCRETE</b> BETON CELLULARE HORMIGÓN ALIGERO BETÃO ALÉGERO	<b>HOLLOW BRICK</b> Brique Creuse LADRILLO hueco TIJOLO OCO	<b>CONCRETE HOLLOW BLOCK</b> BETON CREUSE HORMIGÓN hueco BLOCO DE BETÃO OCO	
								<b>JUNIOR</b> 28
								<b>JUNIOR-OP7</b> 28
								<b>JUNIOR-C</b> 28
								<b>JUNIOR A2+A4</b> 29
								<b>AH-VAR</b> 29
								<b>AH-MAN</b> 29
								<b>ANAN23</b> 30
								<b>ANAN51</b> 30
								<b>ANANZ50</b> 30
								<b>TN2A</b> 31
								<b>TN8A</b> 31
								<b>ANANT</b> 31
								<b>HWA-HE</b> 32
								<b>HWA-CO</b> 32
								<b>HWA-SI</b> 32
								<b>HWA</b> 33
								<b>TAPLA-N</b> 33
								<b>TAPLA-ZP</b> 33































































































# ÍNDICE

								PAG.		
<b>CONCRETE</b> BETÓN HORMIGÓN BETÃO	<b>REINFORCED CONCRETE</b> BETÓN ARMADO BETÃO ARMADO	<b>STONE</b> PIEDRA PEDRA	<b>PLASTERBOARD</b> PLAQUES DE PLÂTRE PANEL YESO LAMINADO PLACA DE GESSO	<b>SOLID BRICK</b> BRIQUE PLANO LADRILLO MACIZO TIJOLO MACIÇO	<b>AERATED CONCRETE</b> BETÓN CELULAR LADRILLO ALIGERO BETÃO ALÉGERO	<b>HOLLOW BRICK</b> BRIQUE CREUSE LADRILLO HUECO TIJOLO OCO	<b>CONCRETE HOLLOW BLOCK</b> BETÓN CREUSE HORMIGÓN HUECO BLOCO DE BETÃO OCO			
								<b>AQTR</b>		36
								<b>PBQ</b>		36
								<b>AQTM</b>		36
								<b>EIG</b>		38
								<b>TANUDO</b>		38
								<b>TANY</b>		39
								<b>TANYCO</b>		39
								<b>TAPLAS</b>		39
								<b>TNCA</b>		40
								<b>TNCC</b>		40
								<b>TNCAI</b>		41
								<b>TN6A</b>		41
								<b>TN6H</b>		41
								<b>EIG PLUS-A</b>		42
								<b>EIG PLUS-H</b>		42
								<b>EIG PLUS-AI</b>		42
								<b>EIG PLUS-HI</b>		42
								<b>TUNA</b>		43

# ÍNDICE

PAG.			CONCRETE BETÓN HORMIGÓN BETÃO	REINFORCED CONCRETE BETÓN ARMADO HORMIGÓN ARMADO BETÃO ARMADO	STONE PIERRE PIEDRA PEDRA	ADOBE BRICK BRIQUE ADOBE LADRILLO DE ADOBE TIJOLO REFRACTARIO	SOLID BRICK BRIQUE BLANC LADRILLO MACIZO TIJOLO MACIÇO	AERATED CONCRETE BLOC ALÉVIER BLOCO ALICERÇO BETÃO LIGERO	HOLLOW BRICK BRIQUE CREUSE LADRILLO HUECO TIJOLO OCO	CONCRETE HOLLOW BLOCK BETÓN CREUSE HORMIGÓN HUECO BLOCO DE BETÃO OCO
43		TUNH								
43		TUNAI								
43		TUNHI								



PAG.			STEEL PIPE TUBE ACIER TUBO DE FERRO TUBO DE AÇO	COOPER PIPE TUBE COBRE TUBO DE COBRE	PVC PIPE TUBE PLASTIQUE TUBO DE PVC	FLEXIBLE PIPE TUBE FLEXIBLE TUBO FLEXIVEL	CABLE CABLE CABO	GAS PIPE TUBE DE GAZ TUBO DE GÁS	STAINLESS STEEL PIPE TUBE ACIER INOXYDABLE TUBO INOXIDABLE TUBO INOX	CHROME PIPE TUBE CHROME TUBO CROMADO
44		BR WHITE								
44		BR BLACK								
45		BR GREEN								
45		BR BROWN								
45		BR YELLOW								
45		BR BLUE								
45		BR RED								
46		BRID								
46		BR PLUG W								
46		BR PLUG B								
46		BR BASE W/B								
46		CINPER								

# ÍNDICE

METAL ELEMENTS ASSEMBLAGE DE ÉLÉMENTS PERFILES DE CHAPA PERFIS DE PLACA	METAL PANELS ASSEMBLAGE DE TOILES CHAPAS UNIDÃO DE CHAPA	BEAM IPN - IPE - HEA - 4 up 15 mm. POULTRÉ IPN - IPE - HEA - 4 a 15 mm. VIGAL IPN - IPE - HEA - 4 a 15 mm. VIGA IPN - IPE - HEA - 4 a 15 mm.	FIBRECEMENT FIBRE-CIMENT FIBROCEMENTO	SANDWICH PANELS PANEL SANDWICH PAINEL SANDWICH	ALUMINIUM WINDOWS - ELEMENTS CUIVRE ALUMINIUM CASA DE ALUMINIO CALHA DE ALUMINIO	PVC WINDOWS POUR L'AMÉNAGERIE PVC CARPINTERIA DE PVC CARPINARIA DE PVC	WOOD ON STEEL IPN ASSEMBLAGE BOIS SUR ACIER MADEIRA SOBRE IPN DE AÇERO MADEIRA SOBRE IPN DE FERRO				PAG.
								TBE DIN-7504-K			48
								TBE+TARNE DIN-7504-K			49
								TBE- A2 DIN-7504-K			50
								TARNE			50
								TARNE-A2			50
								TRE DIN-7504-K			50
								TRE+TARNE DIN-7504-K			50
								TVI			51
								TVI+TARNE			51
								TRB			51
								TRB			51
								TBI BIMETAL			52
								TBI+TARNE BIMETAL			52
								TVIB BIMETAL			52
								TVIB+TARNE BIMETAL			52
								TFI			53
								TS3			53
								TS3+TARNE			53

# ÍNDICE

PAG.

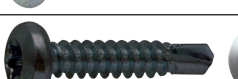











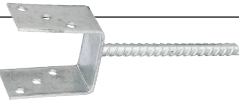

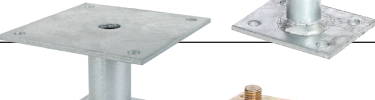
			METAL ELEMENTS ASSEMBLAGE DE ELEMENTS PERFILES DE CHAPA PEFIS DE CHAPA	METAL PANELS ASSEMBLAGE DE TOILES L'CHAPAS LUNAO DE CHAPA	ALUMINIUM WINDOWS - ELEMENTS POUR LA MENUISERIE ALUMINIUM CARPINTERIA DE ALUMINIUM CALHA DE ALUMIUM	PVC WINDOWS POUR LA MENUISERIE PVC CARPINTERIA DE PVC CARPINTERIA DE PVC	WOOD ON STEEL IPN ASSEMBLAGE BOIS SUR ACIER MADEIRA SOBRE IPN DE FERRO	BEAM IPN - IPE - HEA - HEA 4 up 15 mm. VIGAS IPN - IPE - HEA - HEA 4 a 15mm. VIGA IPN - IPE - HEA - HEA 4 a 15mm.	SANDWICH PANELS PANNELS SANDWICH PANEL SANDWICH PANEL SANDWICH	FIBRECEMENT FIBRE-CIMENT FIBROCIMENTO
53		TS5								
53		TS5+TARNE								
54	 	TABA								
54	 	TABA-TX								
55	 	TBCEZ								
55		TBCEN								
55		TBCEB								
55		TBCEL								
55	 	TBCEI-A2								
55	 	TACEZ								
55		TACEN								
55		TACEB								
55	 	TACEI-A2								
56	 	TBRZ DIN-7504-N								
56		TBRN DIN-7504-N								
57	 	TBRZ-TX DIN-7504-N								
57		TBRN-TX DIN-7504-N								
57		TCR								
58	 	TBR-INOX DIN-7504-N								

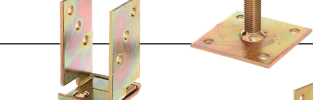
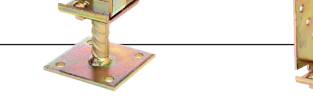
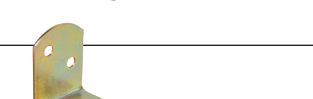
# ÍNDICE

METAL ELEMENTS ASSEMBLAGES DE ELEMENTS PERFILES DE CHAPA PERFIS DE PLACA	METAL PANELS ASSEMBLAGE DE TOILES LIG. CHAPAS UNÃO DE CHAPA	ALUMINIUM WINDOWS - ELEMENTS POUR LA MENUISERIE ALUMINIUM CARPINTERIA DE ALUMINIO CALHA DE ALUMINIO	PVC WINDOWS POUR LA MENUISERIE PVC CARPINTERIA DE PVC CARPINTERIA DE PVC	WOOD ON STEEL IPN ASSEMBLAGE BOIS SUR ACIER MADEIRA SOBRE IPN DE AÇERO MADEIRA SOBRE IPN DE FERRO	PINE WOOD BOIS DE PIN MADEIRA PINHO	THIN WOOD BOIS FEÜLLU MADEIRA FINA MADEIRA FINA	PLASTERBOARD PLAQUES DE PLÂTRE PANEL YESO LAMINADO PLACA DE GESSO			PAG.
								<b>TBR-PAINT DIN-7504-N</b>		58
								<b>TBP DIN-7504-P</b>		59
								<b>TBP DIN-7504-P</b>		59
								<b>TPVC-10</b>		60
								<b>TPVC-20</b>		60
								<b>TPVC-20</b>		60
								<b>TPVC-40</b>		60
								<b>TPVC-50</b>		60
								<b>TAU</b>		61
								<b>TAU+TARNE</b>		61
								<b>DIN-7981</b>		62
								<b>DIN-7981 BLACK Z.</b>		63
								<b>DIN-7981 WHITE P.</b>		63
								<b>DIN-7982</b>		64
								<b>TINV</b>		65
								<b>TINV</b>		65
								<b>TINV-A2</b>		65
								<b>ESTINV</b>		65



# ÍNDICE





















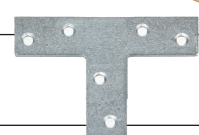

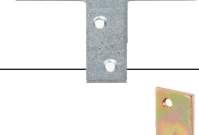





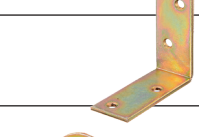

















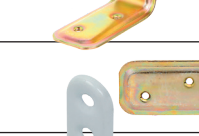

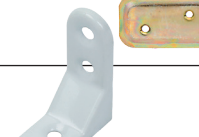





METAL ELEMENTS ASSI, PLACAS DE ALUMÍNIO, PERFILES DE CHAPA, PERFIS DE PLACA		SOLID BRICK BRIQUE PLÔME, LADRILHO, LADRILHO, TIJOLO, MAÇICO		STONE PIÈRE, PIEDRA, PEDRA		AERATED CONCRETE BETON CELLULAIRE, HORMIGÓN LIGERO, BETÃO LIGERO		CONCRETE HOLLOW BLOCK BETON CASAS, HORMIGÓN HUECO, BLOCO DE BETÃO OCO		CONCRETE BETON, HORMIGÓN, BETÃO		PINE WOOD BOIS PIN, MADEIRA PINO, MADEIRA PINHO		THIN WOOD BOIS FEUILLU, MADEIRA FINA, MADEIRA FINA		PAG.
														CM		74
														CM		74
														CM		74
														CM		74
														CM		75
														CM		75
														CM		75
														CM		75
														CM		76
														CM		76
														CM		76
														CM		76
														CM		77
														CM		77
														CM		77
														CM		77
														CM		78
														CM		78

# ÍNDICE

PAG.

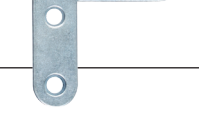
					METAL ELEMENTS ASSEMBLY ELEMENTS PERFILES DE CHAPA PERFIS DE PLACA	SOLID BRICK BRIQUE PLÉNE LADRILLO MASADO TIJOLO MAÇCO	STONE PIERRE PIEDRA PEDRA	AERATED CONCRETE BETÓN CELULAR HORMIGÓN LIGERO BETÃO LIGERO	CONCRETE HOLLOW BLOCK BETÓN CELS HORMIGÓN HUECO BLOCO DE BETÃO OCO	CONCRETE BETÓN HORMIGÓN BETÃO	PINE WOOD BOS PIN MADEIRA PINO MADEIRA PINHO	THIN WOOD BOS FEIJULLU MADEIRA FINA MADEIRA FINA
78			CM									
78			CM									
79			CM									
79			CM									
79			CM									
79			CM									
80			CM									
80			CM									
80			CM									
80			CM									
80			CM									
80			CM									
81			CM									
81			CM									
81			CM									
81			CM									
82			CM									
82			CM									
82			CM									

# ÍNDICE

METAL ELEMENTS ASSEMBLAGES DE ELEMENTOS PERFILES DE CHAPA PERFIS DE PLACA	SOLID BRICK BRIQUE PLÉNE LADRILLO MASADO TIJOLO MACIÇO	STONE PIERRE PIEDRA PEDRA	AERATED CONCRETE BETON CELLULAIRE HORMIGÓN LIGERO BETÃO LIGERO	CONCRETE HOLLOW BLOCK BETON ALÉVÉ HORMIGÓN HUECO BLOCO DE BETÃO OCO	CONCRETE BETON HORMIGÓN BETÃO	PINE WOOD BOS PIN MADEIRA PINO MADEIRA PINHO	THIN WOOD BOS FEIJULLU MADEIRA FINA MADEIRA FINA			PAG.
										
								CM		82
								CM		83
								CM		83
								CM		83
								CM		83
								CM		84
								CM		84
								CM		84
								CM		84
								CM		84
								CM		85
								CM		85
								CM		85
								CM		85
								CM		85
								CM		85



**THROUGH BOLT ANCHOR FOR HEAVY LOADS**

GOUJON D'ANCRAGE POUR CHARGES LOURDES AM

ANCLAJE MACHO AM, PARA CARGAS ALTAS

BUCHA PERNO "MTA" PARA GRANDES CARGAS

# EIG

European Import Group

# 1

## METAL ANCHORS CHEVILLES MÉTALLIQUES ANCLAJES METÁLICOS BUCHAS METÁLICAS



### MATERIALS / MATÉRIAUX / MATERIALES / MATERIAIS:



CONCRETE  
BÉTON  
HORMIGÓN  
BETÃO



REINFORCED CONCRETE  
BÉTON ARMÉ  
HORMIGÓN ARMADO  
BETÃO ARMADO



STONE  
PIERRE  
PIEDRA  
PEDRA



SOLID BRICK  
BRIQUE PLEINE  
LADRILLO MACIZO  
TIJOLO MACIÇO



CRACKED CONCRET  
BÉTON FISSURÉ  
HORMIGÓN FISSURADO  
BETÃO FISSURADO



LIGHTWEIGHT CONCRET  
BÉTON LÉGER  
HORMIGÓN LIGERO  
BETÃO LEVE



HOLLOW CONCRETE BLOCK  
BLOC DE BÉTON CREUX  
BLOQUE HUECO HORMIGÓN  
BLOCO DE BETÃO OCO



HOLLOW BRICK  
BRIQUE CREUSE  
LADRILLO HUECO  
TIJOLO OCO



LAMINATED GYPSUM PAN  
PANNEAU DE GYPSE LAM  
PANEL YESO LAMINADO  
PLACA DE GESSO

## MTA

THROUGH BOLT ANCHOR FOR HEAVY LOADS, ZINC PLATED  
 GOUJON D'ANCRAGE MÂLE AMN POUR CHARGES LOURDES, ZINGUÉ  
 ANCLAJE AMN MACHO, PARA CARGAS ALTAS, ZINCADO  
 BUCHA PERNO "MTA" PARA GRANDES CARGAS, ZINCADO

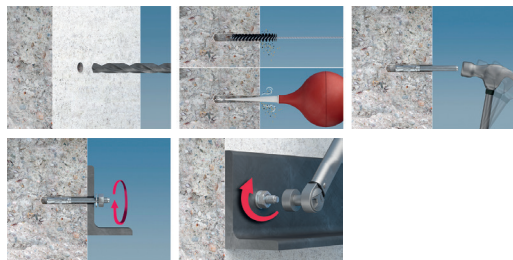
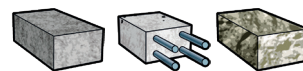
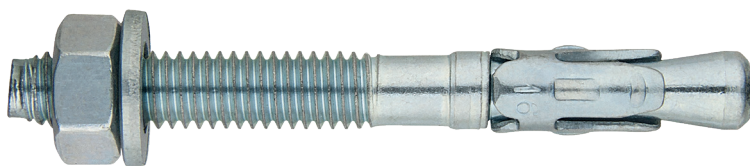

### ZINC PLATED / ZINGUÉ / ZINCADO

CODE / CÓDIGO	SIZE / MESURE MEDIDA	↓ MAX. ↑			€ / 100
AMN06045	M-06 x 45	1	200	1.200	8,73
AMN06060	M-06 x 60	2	200	1.200	9,31
AMN06070	M-06 x 70	12	200	1.200	9,88
AMN06080	M-06 x 80	22	200	1.200	10,87
AMN06090	M-06 x 90	32	200	1.200	13,95
AMN06100	M-06 x 100	42	200	800	14,55
AMN06120	M-06 x 120	62	100	600	14,90
AMN06140	M-06 x 140	82	100	600	15,02
AMN08050	M-08 x 50	4	100	800	10,87
AMN08060	M-08 x 60	3	100	800	12,19
AMN08075	M-08 x 75	5	100	600	12,78
AMN08090	M-08 x 90	20	100	600	13,68
AMN08115	M-08 x 115	45	100	400	17,72
AMN08120	M-08 x 120	50	100	400	18,29
AMN08130	M-08 x 130	60	100	200	21,45
AMN08155	M-08 x 155	85	100	200	22,99
AMN10065	M-10 x 65	1	100	400	18,12
AMN10070	M-10 x 70	3	100	400	18,79
AMN10080	M-10 x 80	13	100	400	19,95
AMN10090	M-10 x 90	10	100	400	20,10
AMN10100	M-10 x 100	20	100	400	22,49
AMN10120	M-10 x 120	40	50	300	25,63
AMN10140	M-10 x 140	60	50	200	29,10
AMN10150	M-10 x 150	70	50	200	30,73
AMN10170	M-10 x 170	90	50	200	40,37
AMN10210	M-10 x 210	130	50	150	94,97
AMN10230	M-10 x 230	150	50	100	99,75
AMN12075	M-12 x 75	5	50	300	25,30
AMN12080	M-12 x 80	3	50	300	27,90
AMN12090	M-12 x 90	13	50	200	28,50
AMN12100	M-12 x 100	8	50	200	30,08
AMN12110	M-12 x 110	18	50	200	31,06
AMN12120	M-12 x 120	28	50	200	35,02
AMN12140	M-12 x 140	48	50	200	39,39
AMN12160	M-12 x 160	68	50	100	49,43
AMN12180	M-12 x 180	88	50	150	56,93
AMN12220	M-12 x 220	128	50	100	131,62
AMN12250	M-12 x 250	158	25	50	163,10
AMN14100	M-14 x 100	5	50	100	123,40
AMN14120	M-14 x 120	12	25	100	136,48
AMN14145	M-14 x 145	37	25	100	166,26
AMN14170	M-14 x 170	62	25	100	177,67
AMN16090	M-16 x 90	4	25	150	51,25
AMN16110	M-16 x 110	24	25	150	57,83
AMN16125	M-16 x 125	3	25	100	61,22
AMN16145	M-16 x 145	23	25	100	68,54
AMN16170	M-16 x 170	48	25	50	87,91
AMN16220	M-16 x 220	98	25	50	108,67
AMN20120	M-20 x 120	5	20	40	110,73
AMN20170	M-20 x 170	23	20	40	130,42
AMN20220	M-20 x 220	73	20	40	162,97

# METAL ANCHORS

CHEVILLES MÉTALLIQUES/ ANCLAJES METÁLICOS/ BUCHAS METÁLICAS

THROUGH BOLT ANCHOR FOR HEAVY LOADS, **STAINLESS STEEL A2**  
GOUJON D'ANCRAGE POUR CHARGES LOURDES AM, **INOXYDABLE A2**  
ANCLAJE MACHO AM, PARA CARGAS ALTAS, **INOXIDABLE A2**  
BUCHA PERNO "MTA" PARA GRANDES CARGAS, **INOXIDÁVEL A2**

## MTA-INOX A2

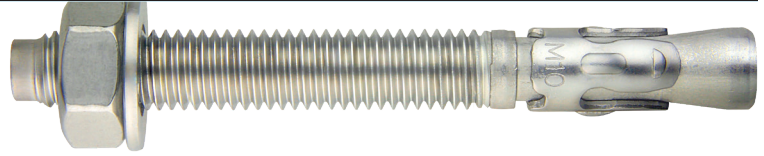

**STAINLESS STEEL A2 - INOXYDABLE A2 - INOX A2**

CODE / CÓDIGO	SIZE / MESURE MEDIDA	↓ ↑ MAX.			€/ 100
AMA206045	M-06 x 45	1	200	1.200	30,60
AMA206060	M-06 x 60	2	200	1.200	33,81
AMA206080	M-06 x 80	22	200	1.200	41,05
AMA206120	M-06 x 120	62	100	600	64,40
AMA206140	M-06 x 140	82	100	600	68,43
AMA206160	M-06 x 160	102	100	600	95,80
AMA208050	M-08 x 50	4	100	800	53,13
AMA208075	M-08 x 75	5	100	600	55,55
AMA208090	M-08 x 90	20	100	600	63,60
AMA208115	M-08 x 115	45	100	400	82,11
AMA210070	M-10 x 70	3	100	400	98,21
AMA210090	M-10 x 90	10	100	400	103,04
AMA210120	M-10 x 120	40	50	300	126,40
AMA210150	M-10 x 150	70	50	200	150,54
AMA212075	M-12 x 75	5	50	300	141,70
AMA212090	M-12 x 90	13	50	200	146,51
AMA212110	M-12 x 110	18	50	200	163,42
AMA212140	M-12 x 140	48	50	200	202,10
AMA216090	M-16 x 90	4	25	150	272,10
AMA216145	M-16 x 145	23	25	100	347,80
AMA216170	M-16 x 170	48	25	50	424,24
AMA220120	M-20 x 120	5	20	40	702,80
AMA220170	M-20 x 170	23	20	40	880,67
AMA220220	M-20 x 220	73	20	40	1.131,83



ASK FOR TECHNICAL INFORMATION / DEMANDEZ INFORMATIONS TECHNIQUES / SOLICITENOS LA FICHA TÉCNICA / SOLICITE A FICHA TÉCNICA PARA MAIS INFORMAÇÕES

THROUGH BOLT ANCHOR FOR HEAVY LOADS, **STAINLESS STEEL A4**  
GOUJON D'ANCRAGE POUR CHARGES LOURDES AM, **INOXYDABLE A4**  
ANCLAJE MACHO AM, PARA CARGAS ALTAS, **INOXIDABLE A4**  
BUCHA PERNO "MTA" PARA GRANDES CARGAS, **INOXIDÁVEL A4**

## A4-MTA-INOX A4

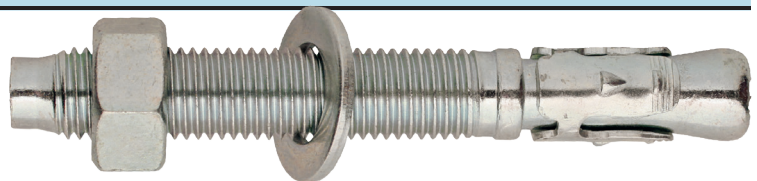
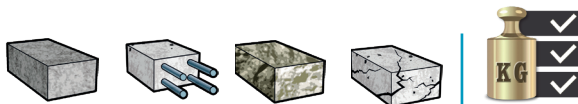

**STAINLESS STEEL A4 - INOXYDABLE A4 - INOX A4**

CODE / CÓDIGO	SIZE / MESURE MEDIDA	↓ ↑ MAX.			€/ 100
A4-BZ2-08X065	M-08 x 65	5	100	400	86,14
A4-BZ2-08X075	M-08 x 75	15	100	400	91,78
A4-BZ2-08X100	M-08 x 100	40	100	400	112,70
A4-BZ2-08X120	M-08 x 120	60	50	200	128,80
A4-BZ2-10X090	M-10 x 90	10	50	200	163,42
A4-BZ2-10X100	M-10 x 100	20	50	200	176,30
A4-BZ2-10X120	M-10 x 120	40	50	200	201,25
A4-BZ2-10X140	M-10 x 140	60	50	200	260,02
A4-BZ2-12X100	M-12 x 100	5	50	200	260,02
A4-BZ2-12X120	M-12 x 120	25	25	100	297,05
A4-BZ2-12X140	M-12 x 140	45	25	100	333,27
A4-BZ2-16X125	M-16 x 125	15	20	80	569,14
A4-BZ2-16X145	M-16 x 145	35	20	80	636,76

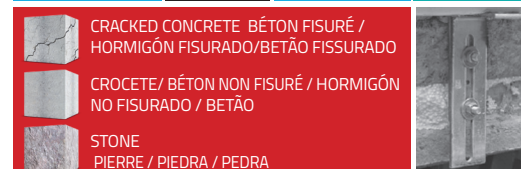

ASK FOR TECHNICAL INFORMATION / DEMANDEZ INFORMATIONS TECHNIQUES / SOLICITENOS LA FICHA TÉCNICA / SOLICITE A FICHA TÉCNICA PARA MAIS INFORMAÇÕES

## MTA-OP7

THROUGH BOLT ANCHOR FOR HEAVY LOADS, **OPTION 7 ETA ASSESSED**  
 GOUJON D'ANCRAGE POUR CHARGES LOURDES, **HOMOLOGUÉ ETA OPTION 7**  
 ANCLAJE MACHO, PARA CARGAS ALTAS, **HOMOLOGACIÓN ETA, OPCIÓN 7**  
 BUCHA PERNO "MTA" PARA GRANDES CARGAS, ZINCADO, **HOMOLOGADA ETA OPÇÃO 7**

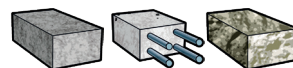
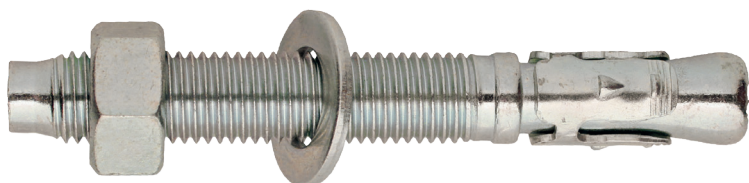

European Technical Approval  
 1488-CPD-0193/W  
 ETA-11/0124  
 ETAG 001/1 & 2  
 Option 7

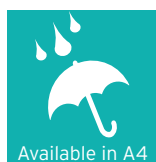

Available in A4



UNITED PLANT  
 CERTIFICATED  
 ISO : 9001 : 2008  
 TS 16949

### MATERIALS / MATERIAUX / MATERIALES / MATERIAIS:



CRACKED CONCRETE  
 BÉTON FISURÉ  
 HORMIGÓN FISURADO  
 BETÃO FISSURADO



STONE  
 PIERRE  
 PIEDRA  
 PEDRA

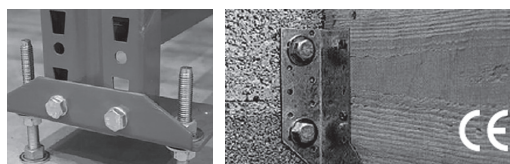

### ZINC PLATED / ZINGUÉ / ZINCADO

CODE / CÓDIGO	SIZE / MESURE MEDIDA	↓ MAX. ↑			€ / 100
BZ-06X45	M-06 x 45	5	200	800	36,05
BZ-06X55	M-06 x 55	5	200	800	39,99
BZ-06X85	M-06 x 85	35	200	800	41,00
BZ-08X50	M-08 x 50	2	200	800	39,77
BZ-08X65	M-08 x 65	15	100	400	50,80
BZ-08X70	M-08 x 70	20	100	400	51,74
BZ-08X80	M-08 x 80	30	100	400	56,55
BZ-08X95	M-08 x 95	45	100	400	60,71
BZ-08X100	M-08 x 100	50	100	400	63,00
BZ-08X105	M-08 x 105	55	100	400	68,10
BZ-08X115	M-08 x 115	65	100	400	73,27
BZ-08X130	M-08 x 130	80	50	200	85,10
BZ-08X165	M-08 x 165	115	50	200	97,41
BZ-10X65	M-10 x 65	5	100	400	67,25
BZ-10X80	M-10 x 80	20	50	200	79,00
BZ-10X95	M-10 x 95	35	50	200	89,44
BZ-10X110	M-10 x 110	50	50	200	92,52
BZ-10X120	M-10 x 120	60	50	200	97,09
BZ-10X150	M-10 x 150	90	50	200	126,00
BZ-12X80	M-12 x 80	2	50	200	111,35
BZ-12X100	M-12 x 100	20	50	200	121,68
BZ-12X120	M-12 x 120	40	25	100	152,99
BZ-12X125	M-12 x 125	45	25	100	159,15
BZ-12X135	M-12 x 135	55	25	100	159,90
BZ-12X180	M-12 x 180	100	25	100	217,29
BZ-12X220	M-12 x 220	140	20	80	276,96
BZ-12X240	M-12 x 240	160	10	40	335,64
BZ-16X105	M-16 x 105	5	25	100	254,95
BZ-16X115	M-16 x 115	15	25	100	278,74
BZ-16X125	M-16 x 125	25	20	80	270,85
BZ-16X140	M-16 x 140	40	20	80	291,38
BZ-16X180	M-16 x 180	80	10	40	361,43
BZ-16X200	M-16 x 200	100	10	40	429,59
BZ-16X240	M-16 x 240	140	10	40	548,98
BZ-20X130	M-20 x 130	5	10	40	514,14
BZ-20X160	M-20 x 160	35	10	40	531,15
BZ-20X215	M-20 x 215	90	10	40	663,68

ASK FOR TECHNICAL INFORMATION / DEMANDEZ INFORMATIONS TECHNIQUES / SOLICITENOS LA FICHA TÉCNICA / SOLICITE A FICHA TÉCNICA PARA MAIS INFORMAÇÕES

# METAL ANCHORS

CHEVILLES MÉTALLIQUES/ ANCLAJES METÁLICOS/ BUCHAS METÁLICAS

THROUGH BOLT ANCHOR FOR HEAVY LOADS, **OPTION 1 ETA ASSESSED**

GOUJON D'ANCRAGE POUR CHARGES LOURDES, **HOMOLOGUÉ ETA OPTION 1**

ANCLAJE MACHO, PARA CARGAS ALTAS, **HOMOLOGACIÓN ETA, OPCIÓN 1**

BUCHA PERNO "MTA" PARA GRANDES CARGAS, ZINCADO, **HOMOLOGADA ETA OPÇÃO 1**

# MTA PLUS-OP1

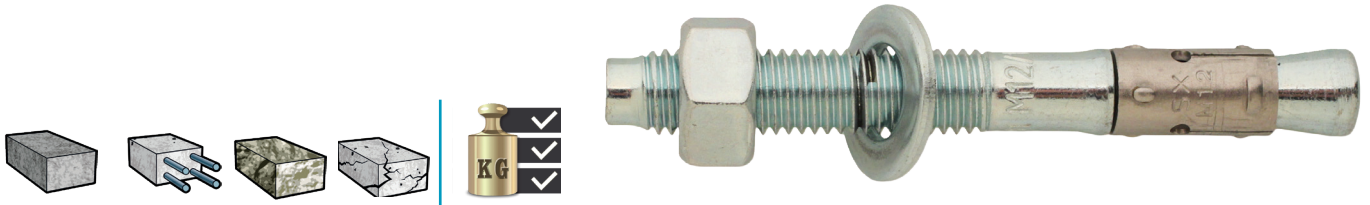

ZINC PLATED / ZINGUÉ / ZINCADO

CODE / CÓDIGO	SIZE / MESURE MEDIDA	MAX. ↓ ↑	ETA 100	ETA 400	€/ 100
BZPLUS08060	M-08 x 60	5	100	400	61,12
BZPLUS08075	M-08 x 75	20	100	400	66,35
BZPLUS08085	M-08 x 85	30	100	400	68,78
BZPLUS08095	M-08 x 95	40	100	400	75,36
BZPLUS08105	M-08 x 105	50	100	400	79,30
BZPLUS08130	M-08 x 130	75	50	200	91,94
BZPLUS08155	M-08 x 155	100	50	200	102,46
BZPLUS10085	M-10 x 85	5	50	200	106,64
BZPLUS10090	M-10 x 90	10	50	200	106,00
BZPLUS10100	M-10 x 100	20	50	200	108,68
BZPLUS10110	M-10 x 110	30	50	200	118,87
BZPLUS10120	M-10 x 120	40	50	200	133,01
BZPLUS10130	M-10 x 130	50	50	200	139,20
BZPLUS10160	M-10 x 160	80	50	200	160,46
BZPLUS10180	M-10 x 180	100	25	100	192,79
BZPLUS12090	M-12 x 90	5	50	200	151,00
BZPLUS12100	M-12 x 100	15	50	200	161,21
BZPLUS12115	M-12 x 115	30	25	100	162,00
BZPLUS12135	M-12 x 135	50	25	100	205,00
BZPLUS12165	M-12 x 165	80	25	100	251,76
BZPLUS12175	M-12 x 175	90	25	100	238,96
BZPLUS12185	M-12 x 185	100	25	100	250,89
BZPLUS16115	M-16 x 115	5	25	100	301,85
BZPLUS16125	M-16 x 125	15	20	80	410,78
BZPLUS16150	M-16 x 150	40	20	80	374,68

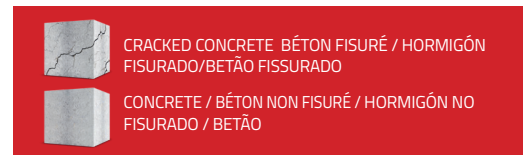
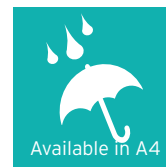

ASK FOR TECHNICAL INFORMATION / DEMANDEZ INFORMATIONS TECHNIQUES / SOLICITENOS LA FICHA TÉCNICA / SOLICITE A FICHA TÉCNICA PARA MAIS INFORMAÇÕES



## BCHP

SLEEVE ANCHOR, FOR HEAVY-DUTY FIXINGS, WITH HEX SCREW, QUALITY 6.8

CHEVILLE POUR CHARGES MOYENNES, VIS TÊTE HEXAGONALE, QUALITE 6.8

ANCLAJE PARA CARGAS MEDIAS, VERSIÓN TORNILLO CALIDAD 6.8

BUCHA BCHP CH PARA GRANDES CARGAS, COM PARAFUSO SEXTAVADO, QUALIDADE 6.8

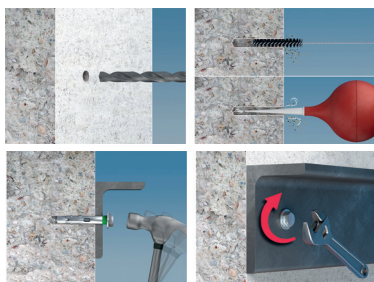
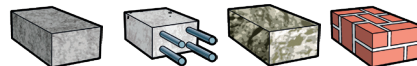

ZINC PLATED / ZINGUÉ / ZINCADO

CODE / CÓDIGO	SIZE / MESURE MEDIDA	↓ MAX. ↑			€ / 100
ACTO08C	M-06 x 45 Ø08	5	200	1.200	9,24
ACTO08L	M-06 x 60 Ø08	15	200	800	10,78
ACTO10C	M-08 x 60 Ø10	5	100	600	16,17
ACTO10L	M-08 x 80 Ø10	15	100	600	20,79
ACTO12C	M-10 x 70 Ø12	5	100	400	29,26
ACTO12L	M-10 x 100 Ø12	25	50	300	36,19
ACTO14C	M-10 x 70 Ø14	5	100	400	49,75
ACTO14L	M-10 x 100 Ø14	25	50	300	65,10
ACTO16C	M-12 x 80 Ø16	5	50	200	55,44
ACTO16L	M-12 x 110 Ø16	25	50	200	67,76
ACTO20C	M-16 x 110 Ø20	15	25	100	138,6

ASK FOR TECHNICAL INFORMATION / DEMANDEZ INFORMATIONS TECHNIQUES / SOLICITENOS LA FICHA TÉCNICA / SOLICITE A FICHA TÉCNICA PARA MAIS INFORMAÇÕES

## BCHO

SLEEVE ANCHOR, FOR HEAVY-DUTY FIXINGS, EYE BOLT

CHEVILLE POUR CHARGES MOYENNES, PITON

ANCLAJE PARA CARGAS MEDIAS, VERSIÓN ARGOLLA

BUCHA CH PARA GRANDES CARGAS, COM OLHAL

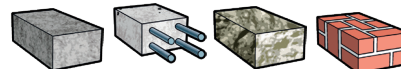
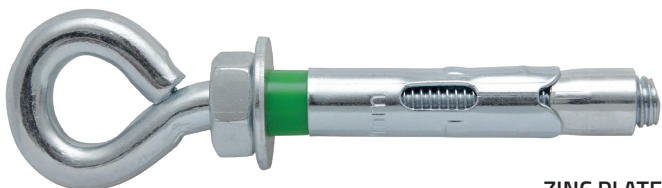

ZINC PLATED / ZINGUÉ / ZINCADO

CODE / CÓDIGO	SIZE / MESURE MEDIDA	↓ MAX. ↑			€ / 100
ACAR08C	M-06 x 45 Ø08	5	100	600	16,94
ACAR10C	M-08 x 60 Ø10	5	100	400	29,26
ACAR12C	M-10 x 70 Ø12	5	50	200	59,29
ACAR14C	M-10 x 70 Ø14	5	50	200	89,60
ACAR16C	M-12 x 80 Ø16	5	25	100	100,10

ASK FOR TECHNICAL INFORMATION / DEMANDEZ INFORMATIONS TECHNIQUES / SOLICITENOS LA FICHA TÉCNICA / SOLICITE A FICHA TÉCNICA PARA MAIS INFORMAÇÕES

## BCHG

SLEEVE ANCHOR, FOR HEAVY-DUTY FIXINGS, HOOK BOLT

ANCLAJE PARA CARGAS MEDIAS, VERSIÓN GANCHO

CHEVILLE POUR CHARGES MOYENNES, CROCHET

BUCHA CH PARA GRANDES CARGAS, COM GANCHO

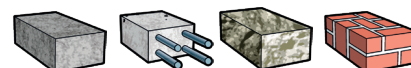
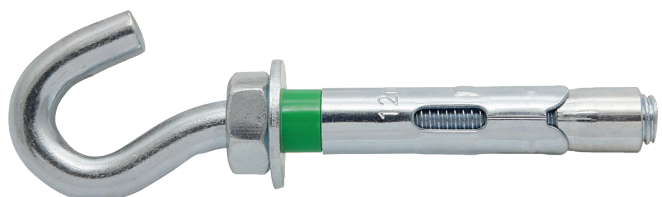

ZINC PLATED / ZINGUÉ / ZINCADO

CODE / CÓDIGO	SIZE / MESURE MEDIDA	↓ MAX. ↑			€ / 100
ACGA08C	M-06 x 45 Ø08	5	100	600	16,94
ACGA10C	M-08 x 60 Ø10	5	100	400	29,26
ACGA12C	M-10 x 70 Ø12	5	50	200	59,29
ACGA14C	M-10 x 70 Ø14	5	50	200	89,60
ACGA16C	M-12 x 80 Ø16	5	25	100	100,1

ASK FOR TECHNICAL INFORMATION / DEMANDEZ INFORMATIONS TECHNIQUES / SOLICITENOS LA FICHA TÉCNICA / SOLICITE A FICHA TÉCNICA PARA MAIS INFORMAÇÕES

# METAL ANCHORS

CHEVILLES MÉTALLIQUES/ ANCLAJES METÁLICOS/ BUCHAS METÁLICAS

SLEEVE ANCHOR, FOR HEAVY-DUTY FIXINGS, **STAINLESS STEEL**  
ANCLAJE PARA CARGAS MEDIAS, VERSIÓN TORNILLO, **INOXIDABLE**  
CHEVILLE POUR CHARGES MOYENNES, VIS TÊTE HEXAGONALE, **INOXYDABLE**  
BUCHA BHP CH PARA GRANDES CARGAS, COM PARAFUSO SEXTAVADO, **INOX**

## BCHP-A

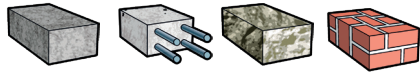

**STAINLESS STEEL A2 - INOXYDABLE A2 - INOX A2**

CODE / CÓDIGO	SIZE / MESURE MEDIDA	MAX. ↓ ↑	KG	KG	€ / 100
ACTO208C	M-06 x 45 Ø08	5	200	1.200	32,20
ACTO208L	M-06 x 60 Ø08	15	200	800	36,23
ACTO210C	M-08 x 60 Ø10	5	100	600	53,35
ACTO210L	M-08 x 80 Ø10	15	100	600	66,01
ACTO212C	M-10 x 70 Ø12	5	100	400	128,80
ACTO212L	M-10 x 100 Ø12	25	50	300	152,30
ACTO214C	M-10 x 70 Ø14	5	100	400	158,75
ACTO214L	M-10 x 100 Ø14	25	50	300	182,30
ACTO216C	M-12 x 80 Ø16	5	50	200	249,60
ACTO216L	M-12 x 110 Ø16	25	50	200	305,90
ACTO220C	M-16 x 110 Ø20	15	25	100	603,75

**STAINLESS STEEL A4  
INOXYDABLE A4 - INOX A4**

CODE / CÓDIGO	€ / 100
BCHPRF00A406045	56,36
BCHPRF00A406060	61,99
BCHPRF00A408060	97,41
BCHPRF00A408080	114,31
BCHPRF00A410070	221,38
BCHPRF00A410100	265,65
BCHPRF00A412080	426,65
BCHPRF00A412100	515,20
BCHPRF00A416110	1022,35

ASK FOR TECHNICAL INFORMATION / DEMANDEZ INFORMATIONS TECHNIQUES / SOLICITENOS LA FICHA TÉCNICA / SOLICITE A FICHA TÉCNICA PARA MAIS INFORMAÇÕES

SLEEVE ANCHOR, FOR HEAVY-DUTY FIXINGS, **8.8 HEX SCREW**  
ANCLAJE PARA CARGAS MEDIAS, VERSIÓN TORNILLO, **CALIDAD 8.8**  
CHEVILLE POUR CHARGES MOYENNES, VIS TÊTE HEXAGONALE, **8,8 QUALITÉ**  
BUCHA BHP CH PARA GRANDES CARGAS, COM PARAFUSO SEXTAVADO, **QUALIDADE 8.8**

## BCHP-8.8

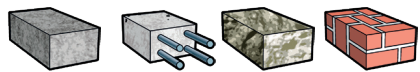

**ZINC PLATED / ZINGUÉ / ZINCADO**

CODE / CÓDIGO	SIZE / MESURE MEDIDA	MAX. ↓ ↑	KG	KG	€ / 100
ACTO8808C	M-06 x 45 Ø08	5	200	1.200	27,05
ACTO8808L	M-06 x 60 Ø08	15	200	800	31,35
ACTO8810C	M-08 x 60 Ø10	5	100	600	44,30
ACTO8810L	M-08 x 80 Ø10	15	100	600	51,90
ACTO8812C	M-10 x 70 Ø12	5	100	400	72,15
ACTO8812L	M-10 x 100 Ø12	25	50	300	89,15
ACTO8816C	M-12 x 80 Ø16	5	50	200	136,23
ACTO8816L	M-12 x 110 Ø16	25	50	200	165,30
ACTO8820C	M-16 x 110 Ø20	15	25	100	292,55

ASK FOR TECHNICAL INFORMATION / DEMANDEZ INFORMATIONS TECHNIQUES / SOLICITENOS LA FICHA TÉCNICA / SOLICITE A FICHA TÉCNICA PARA MAIS INFORMAÇÕES

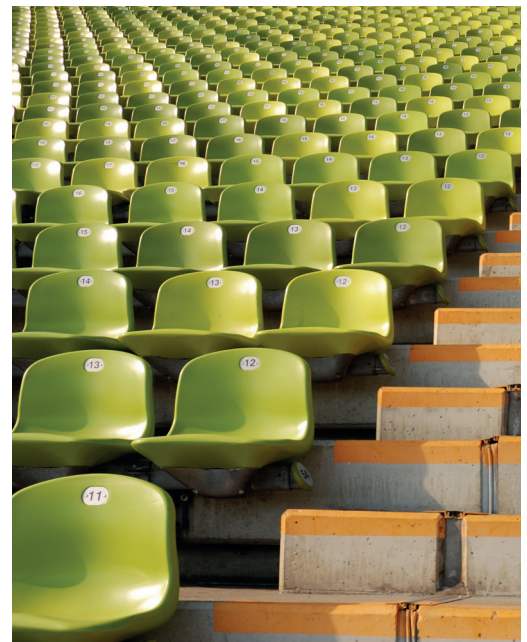

## HVE

HEAVY DUTY ANCHOR FOR HIGH PERFORMANCE IN CONCRETE, HEX HEAD  
 ANCLAJE PARA GRANDES CARGAS, DE ALTA RESISTENCIA, CABEZA HEXAGONAL  
 CHEVILLE DE SÉCURITÉ HAUTES PERFORMANCES, TÊTE HEXAGONALE  
 BUCHA PARA CARGAS ELEVADAS, COM PARAFUSO SEXTAVADO

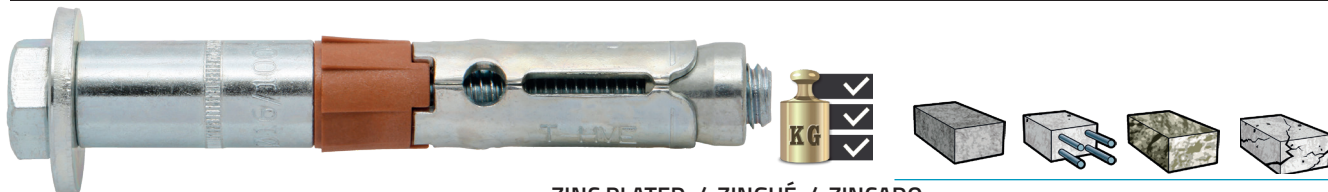

**MATERIALS / MATERIAUX / MATERIALES / MATERIAIS:**

- CRACKED CONCRETE  
BÉTON FISURÉ  
HORMIGÓN FISURADO  
BETÃO FISSURADO
- UNCRACKED CONCRETE  
BÉTON NON FISURÉ  
HORMIGÓN NO FISURADO  
BETÃO

ZINC PLATED / ZINGUÉ / ZINCADO

CODE / CÓDIGO	SIZE / MESURE MEDIDA	↓ MAX. ↑			€ / 100
HVE10/5	M-06x070 / 10	5	100	400	180,33
HVE10/15	M-06x080 / 10	15	80	320	192,33
HVE10/35	M-06x100 / 10	35	70	280	213,91
HVE12/10	M-08x080 / 12	10	50	200	256,02
HVE12/30	M-08x100 / 12	30	40	160	300,70
HVE12/50	M-08x120 / 12	50	30	120	332,84
HVE16/20	M-10x100 / 16	20	20	80	405,85
HVE16/40	M-10x120 / 16	40	20	80	461,57
HVE16/60	M-10x140 / 16	60	20	80	470,67
HVE18/20	M-12x120 / 18	20	15	60	617,02
HVE18/50	M-12x150 / 18	50	15	60	774,45
HVE24/20	M-16x140 / 24	20	5	20	1.341,73
HVE24/50	M-16x170 / 24	50	5	20	1.661,36

ASK FOR TECHNICAL INFORMATION / DEMANDEZ INFORMATIONS TECHNIQUES / SOLICITENOS LA FICHA TÉCNICA / SOLICITE A FICHA TÉCNICA PARA MAIS INFORMAÇÕES

## HVE-02

HEAVY DUTY ANCHOR FOR HIGH PERFORMANCE IN CONCRETE, PROJECTING BOLT  
 CHEVILLE DE SÉCURITÉ HAUTES PERFORMANCES, TIGE FILETÉE  
 ANCLAJE PARA GRANDES CARGAS, DE ALTA RESISTENCIA, ESPÁRRAGO  
 BUCHA PARA CARGAS ELEVADAS, COM PERNO



ZINC PLATED / ZINGUÉ / ZINCADO

CODE / CÓDIGO	SIZE / MESURE MEDIDA	↓ MAX. ↑			€ / 100
HVE02-10/15	M-06x070 / 10	5	80	320	209,87
HVE02-10/35	M-06x080 / 10	15	70	280	245,54
HVE02-10/5	M-06x100 / 10	35	100	400	195,92
HVE02-10/55	M-06x120 / 10	55	50	200	292,57
HVE02-12/10	M-08x080 / 12	10	50	200	315,74
HVE02-12/30	M-08x100 / 12	30	40	160	342,18
HVE02-12/50	M-08x120 / 12	50	30	120	401,92
HVE02-12/70	M-08x140 / 12	70	30	120	393,09
HVE02-16/20	M-10x100 / 16	20	20	80	463,11
HVE02-16/40	M-10x120 / 16	40	20	80	513,49
HVE02-16/60	M-10x140 / 16	60	20	80	566,53
HVE02-16/80	M-10x160 / 16	80	20	80	678,16
HVE02-18/100	M-12x120 / 18	20	10	40	1.099,22
HVE02-18/20	M-12x150 / 18	50	15	60	692,91
HVE02-18/50	M-12x170 / 18	70	15	60	803,71
HVE02-18/70	M-12x200 / 18	100	10	40	963,52
HVE02-24/100	M-16x140 / 24	20	5	20	2.370,35
HVE02-24/20	M-16x170 / 24	50	5	20	1.616,04
HVE02-24/50	M-16x200 / 24	80	5	20	1.596,89
HVE02-24/80	M-16x220 / 24	100	5	20	2.055,26

ASK FOR TECHNICAL INFORMATION / DEMANDEZ INFORMATIONS TECHNIQUES / SOLICITENOS LA FICHA TÉCNICA / SOLICITE A FICHA TÉCNICA PARA MAIS INFORMAÇÕES



# DIRECT FIXING SCREWS

VIS DE FIXATION DIRECTE / TORNILLOS DE FIJACIÓN DIRECTA / PARAFUSOS DE FIXAÇÃO DIRETA

## CONCRETE SCREW ANCHOR, HEXAGON HEAD

VIS A BÊTON, TÊTE HEXAGONALE



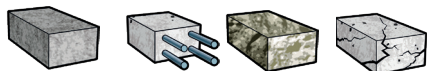

NCLAJE-TORNILLO FIJACIÓN DIRECTA HORMIGÓN, CABEZA HEXAGONAL CON ARANDELA

PARAFUSO PARA BETÃO CABEÇA SEXTAVADA COM FALSA ANILHA

# BT



SILVER RUSPERT

CODE / CÓDIGO	SIZE / MESURE MEDIDA		 MAX.			€ / 100
BT060030	6x30 Ø 6	7,75	5	100	800	33,85
BT060050	6x50 Ø 6	7,75	10	100	800	49,01
BT060075	6x75 Ø 6	7,75	20	100	400	59,12
BT060100	6x100 Ø 6	7,75	45	100	400	79,20
BT080060	8x60 Ø 8	9,85	10	50	200	105,65
BT080075	8x75 Ø 8	9,85	10	50	200	113,81
BT080100	8x100 Ø 8	9,85	35	50	200	148,23
BT100060	10x60 Ø 10	11,95	10	50	200	159,50
BT100075	10x75 Ø 10	11,95	15	50	200	180,41
BT100100	10x100 Ø 10	11,95	25	50	200	222,00
BT100130	10x130 Ø 10	11,95	55	25	100	295,27
BT100150	10x150 Ø 10	11,95	75	25	100	346,85
BT100200	10x200 Ø 10	11,95	125	20	80	611,73
BT100240	10x240 Ø 10	11,95	165	20	80	631,93
BT120075	12x75 Ø 12	14,08	20	25	100	316,75
BT120100	12x100 Ø 12	14,08	5	25	100	371,03
BT120150	12x150 Ø 12	14,08	55	20	80	523,05
BT140080	14x80 Ø 14	16,23	20	20	80	519,68
BT140100	14x100 Ø 14	16,23	35	20	80	602,18
BT140130	14x130 Ø 14	16,23	15	20	80	691,98
BT140150	14x150 Ø 14	16,23	35	10	40	779,31
BT160100	16x100 Ø 16	18,30	40	20	80	676,80
BT160150	16x150 Ø 16	18,30	80	10	40	899,03

 Logiciel de calcul

 **FB120**

European Technical Approval  
1488-CPD-0383/W  
ETA-13/0934  
ETAG 001/3  
Option1

 CRACKED CONCRETE / BÉTON FISURÉ / HORMIGÓN FISURADO/BETÃO FISSURADO

 CONCRETE / BÉTON NON FISURÉ / HORMIGÓN NO FISURADO / BETÃO

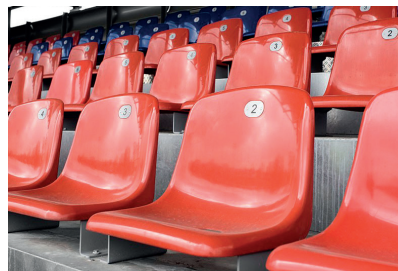

ASK FOR TECHNICAL INFORMATION / DEMANDEZ INFORMATIONS TECHNIQUES / SOLICITENOS LA FICHA TÉCNICA / SOLICITE A FICHA TÉCNICA PARA MAIS INFORMAÇÕES

## CONCRETE SCREW ANCHOR, COUNTERSUNK HEAD

VIS A BÊTON, TÊTE FRAISEE



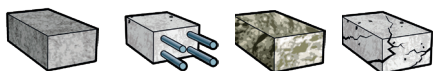

ANCLAJE-TORNILLO FIJACIÓN DIRECTA HORMIGÓN, CABEZA PLANA

PARAFUSO PARA BETÃO CABEÇA DE EMBEBER

# BTF



SILVER RUSPERT

CODE / CÓDIGO	SIZE / MESURE MEDIDA		 MAX.			€ / 100
BTF08070	8x70 Ø 8	9,85	10	100	800	161,22
BTF08100	8x100 Ø 8	9,85	40	100	800	191,93
BTF08140	8x140 Ø 8	9,85	80	100	400	277,76
BTF10080	10x80 Ø 10	11,95	10	50	200	264,45
BTF10100	10x100 Ø 10	11,95	30	50	200	283,57
BTF10160	10x160 Ø 10	11,95	90	50	200	421,24
BTF12100	12x100 Ø 12	14,08	20	50	200	406,50
BTF12120	12x120 Ø 12	14,08	4	50	200	444,20
BTF12180	12x180 Ø 12	14,08	100	50	200	828,62

ASK FOR TECHNICAL INFORMATION / DEMANDEZ INFORMATIONS TECHNIQUES / SOLICITENOS LA FICHA TÉCNICA / SOLICITE A FICHA TÉCNICA PARA MAIS INFORMAÇÕES



## THCH

CONCRETE SCREW, HEX HEAD, HI-LO THREAD, DIAMOND POINT

VIS À BÉTON, TÊTE HEXAGONALE, FILET HI-LO, POINTE DIAMANT

TORNILLO PARA HORMIGÓN, CABEZA HEXAGONAL, ROSCA HI-LO, PUNTA DIAMANTE

PARAFUSO PARA BETÃO CABEÇA SEXTAVADA COM PONTA DIAMANTE

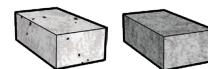

Acabado: BLUE RUSPERT / AZUL RUSPERT

CODE / CÓDIGO	SIZE / MESURE MEDIDA	DRILL / PERÇAGE BROCA A UTILIZAR	↓ MAX. ↑				€ / 100
THCH1665032	6,5 x 32	Ø 5	2	8 + Ranura	1.000	3.000	<b>8,39</b>
THCH1665045	6,5 x 45	Ø 5	15	8 + Ranura	500	2.000	<b>10,36</b>
THCH1665057	6,5 x 57	Ø 5	27	8 + Ranura	500	2.000	<b>13,83</b>
THCH1665070	6,5 x 70	Ø 5	40	8 + Ranura	500	1.500	<b>16,32</b>
THCH1665080	6,5 x 80	Ø 5	50	8 + Ranura	250	1.000	<b>20,64</b>
THCH1665100	6,5 x 100	Ø 5	70	8 + Ranura	250	1.000	<b>23,95</b>
THCH1665115	6,5 x 115	Ø 5	85	8 + Ranura	250	1.000	<b>27,13</b>
THCH1665125	6,5 x 125	Ø 5	95	8 + Ranura	250	1.000	<b>29,79</b>
THCH1665150	6,5 x 150	Ø 5	120	8 + Ranura	250	1.000	<b>39,26</b>

ASK FOR TECHNICAL INFORMATION / DEMANDEZ INFORMATIONS TECHNIQUES / SOLICITENOS LA FICHA TÉCNICA / SOLICITE A FICHA TÉCNICA PARA MAIS INFORMAÇÕES

## THCH+TARNE

ASSEMBLED WITH EPDM WASHER P-16

MONTÉ AVEC EPDM RONDELLE P-16

MONTADO CON ARANDELA EPDM P-16

MONTADO COM EPDM Ø 16

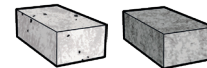
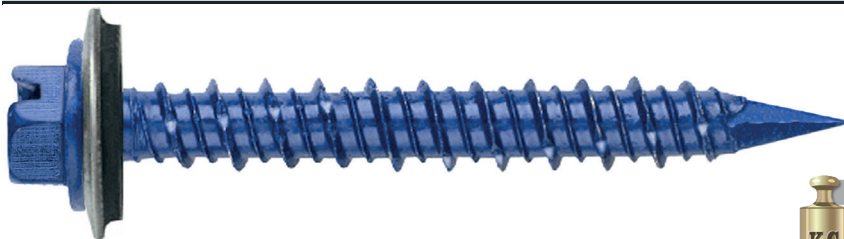

Acabado: AZUL RUSPERT / BLUE RUSPERT

CODE / CÓDIGO	SIZE / MESURE MEDIDA	DRILL / PERÇAGE BROCA A UTILIZAR	↓ MAX. ↑				€ / 100
THCH1665032	6,5 x 32 / P16	Ø 5	2	8 + Ranura	1.000	2.000	<b>12,70</b>
THCH1665045	6,5 x 45 / P16	Ø 5	15	8 + Ranura	500	1.500	<b>14,95</b>
THCH1665057	6,5 x 57 / P16	Ø 5	27	8 + Ranura	500	1.500	<b>18,24</b>
THCH1665070	6,5 x 70 / P16	Ø 5	40	8 + Ranura	500	1.500	<b>20,73</b>
THCH1665080	6,5 x 80 / P16	Ø 5	50	8 + Ranura	250	750	<b>25,49</b>
THCH1665100	6,5 x 100 / P16	Ø 5	70	8 + Ranura	250	750	<b>29,20</b>
THCH1665115	6,5 x 115 / P16	Ø 5	85	8 + Ranura	250	500	<b>32,66</b>
THCH1665125	6,5 x 125 / P16	Ø 5	95	8 + Ranura	250	500	<b>36,88</b>
THCH1665150	6,5 x 150 / P16	Ø 5	120	8 + Ranura	250	500	<b>45,49</b>

ASK FOR TECHNICAL INFORMATION / DEMANDEZ INFORMATIONS TECHNIQUES / SOLICITENOS LA FICHA TÉCNICA / SOLICITE A FICHA TÉCNICA PARA MAIS INFORMAÇÕES

# DIRECT FIXING SCREWS

VIS DE FIXATION DIRECTE / TORNILLOS DE FIJACIÓN DIRECTA / PARAFUSOS DE FIXAÇÃO DIRETA

**CONCRETE SCREW, SHALLOW COUNTERSUNK HEAD, TX-30 RECESS, HI-LO, ZINC PLATED**

VIS À BÉTON, TÊTE PLATE, TX-30, HI-LO, ZINGUÉE

TORNILLO PARA HORMIGÓN, CABEZA PLANA, HUELLA TX-30, ROSCA HI-LO, ZINCADO

PARAFUSO PARA BETÃO, CABEÇA PLANA TX-30, ZINCADO

## THCP

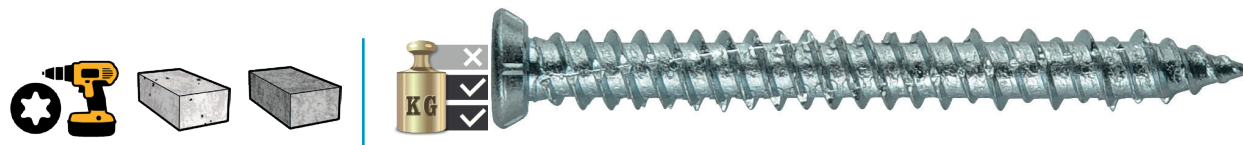

CODE / CÓDIGO	SIZE / MESURE MEDIDA	BROCA A UTILIZAR DRILL / PERÇAGE	MAX.				€ / 100
THCP75072	7,5 x 72	Ø 6	32	TX-30	100	1.200	<b>16,17</b>
THCP75092	7,5 x 92	Ø 6	52	TX-30	100	1.200	<b>19,74</b>
THCP75112	7,5 x 112	Ø 6	72	TX-30	100	1.200	<b>25,13</b>
THCP75132	7,5 x 132	Ø 6	92	TX-30	100	600	<b>29,26</b>
THCP75152	7,5 x 152	Ø 6	112	TX-30	100	600	<b>37,21</b>
THCP75182	7,5 x 182	Ø 6	142	TX-30	100	300	<b>50,89</b>
THCP75212	7,5 x 212	Ø 6	172	TX-30	100	300	<b>69,86</b>

ASK FOR TECHNICAL INFORMATION / DEMANDEZ INFORMATIONS TECHNIQUES / SOLICITENOS LA FICHA TÉCNICA / SOLICITE A FICHA TÉCNICA PARA MAIS INFORMAÇÕES

**CONCRETE SCREW, CYLINDRICAL HEAD, TX-30 RECESS, HI-LO, ZINC PLATED**

VIS À BÉTON, TÊTE CYLINDRIQUE, TX-30, HI-LO, ZINGUÉE

TORNILLO PARA HORMIGÓN, CABEZA CILÍNDRICA, HUELLA TX-30, ROSCA HI-LO, ZINCADO

PARAFUSO PARA BETÃO CABEÇA CILINDRICA TX-30, ZINCADO

## THCC

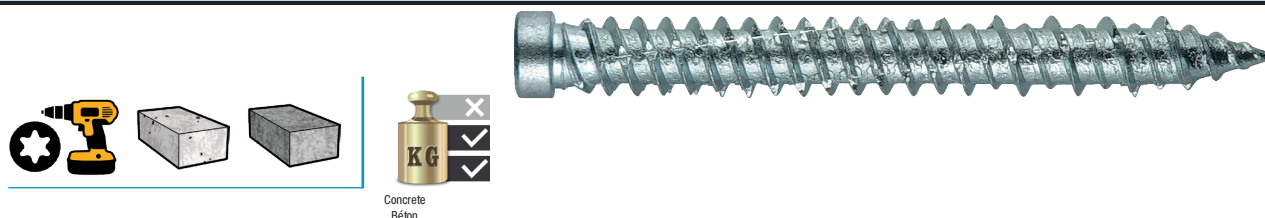

CODE / CÓDIGO	SIZE / MESURE MEDIDA	BROCA A UTILIZAR DRILL / PERÇAGE	MAX.				€ / 100
THCC75072	7,5 x 72	Ø 6	32	TX-30	100	1.200	<b>16,77</b>
THCC75092	7,5 x 92	Ø 6	52	TX-30	100	1.200	<b>20,02</b>
THCC75112	7,5 x 112	Ø 6	72	TX-30	100	1.200	<b>25,83</b>
THCC75132	7,5 x 132	Ø 6	92	TX-30	100	600	<b>30,66</b>

ASK FOR TECHNICAL INFORMATION / DEMANDEZ INFORMATIONS TECHNIQUES / SOLICITENOS LA FICHA TÉCNICA / SOLICITE A FICHA TÉCNICA PARA MAIS INFORMAÇÕES

**PVC CAP, FOR CONCRETE SCREW TX-30**

CAPUCHON PVC, POR VIS À BÉTON TX-30

TAPÓN DE PVC, PARA TORNILLO HORMIGÓN TX-30

TAMPA PVC, PARA PARAFUSO BETÃO TX-30

## TPTH

CODE CÓDIGO	COLOURS / COULEURS COLORES	SIZE / MESURE MEDIDA				€ / 100
TPTHBL	WHITE / BLANCHE / BLANCO / BRANCO	Ø 13 / Ø 4	TX-30	1.000	12.000	<b>2,59</b>
TPTHMA	BROWN / BRUN MARRÓN / CASTANHO	Ø 13 / Ø 4	TX-30	1.000	12.000	<b>2,59</b>

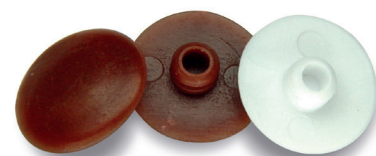

# JUNIOR

**DROP IN ANCHOR FOR HEAVY LOADS**  
 CHEVILLE DE FRAPPE POUR CHARGES LOURDES  
 ANCLAJE HEMBRA PARA GRANDES CARGAS  
 BUCHA JUNIOR C/ TACO INT. PARA GRANDES CARGAS

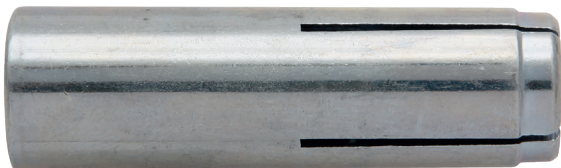

ZINC PLATED / ZINGUÉ / ZINCADO

CODE / CÓDIGO	SIZE / MESURE MEDIDA	BROCA Ø			€ / 100
AHNM06	M-06 x 25 Ø08	8	100	2.000	<b>8,82</b>
AHNM08	M-08 x 30 Ø10	10	100	2.000	<b>11,62</b>
AHNM10	M-10 x 40 Ø12	12	50	1.000	<b>19,46</b>
AHNM12	M-12 x 50 Ø15	15	50	1.000	<b>35,77</b>
AHNM16	M-16 x 65 Ø20	20	25	200	<b>91,28</b>
AHNM20	M-20 x 80 Ø25	25	25	200	<b>195,65</b>

ASK FOR TECHNICAL INFORMATION / DEMANDEZ INFORMATIONS TECHNIQUES / SOLICITENOS LA FICHA TÉCNICA / SOLICITE A FICHA TÉCNICA PARA MAIS INFORMAÇÕES

# JUNIOR-OP7

**DROP IN ANCHOR FOR HEAVY LOADS, OPTION 7 ETA APPROVED**  
 CHEVILLE DE FRAPPE POUR CHARGES LOURDES, **HOMOLOGUÉ ETA OPTION 7**  
 ANCLAJE HEMBRA PARA GRANDES CARGAS, **HOMOLOGACIÓN ETA, OPCIÓN 7**  
 BUCHA JUNIOR C/ TACO INT. PARA GRANDES CARGAS, **HOMOLOGADA ETA OPÇÃO 7**

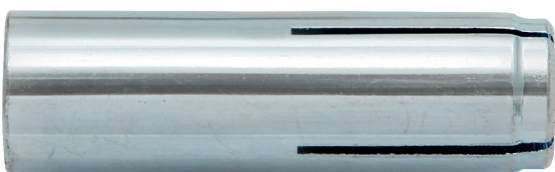

ZINC PLATED / ZINGUÉ / ZINCADO

CRACKED CONCRETE / BÉTON FISURÉ / HORMIGÓN FISURADO/BETÃO FISSURADO  
 CONCRETE / BÉTON NON FISURÉ / HORMIGÓN NO FISURADO / BETÃO

European TECHNICAL ASSESSMENT  
**OPTION 1**  
 15/0525

**FB120**

Available in A4

CODE / CÓDIGO	SIZE / MESURE MEDIDA	BROCA Ø			€ / 100
SAPLUS06	M-06 x 25 Ø08	8	100	800	<b>11,68</b>
SAPLUS08	M-08 x 30 Ø10	10	100	800	<b>18,72</b>
SAPLUS10	M-10 x 40 Ø12	12	100	800	<b>27,28</b>
SAPLUS12	M-12 x 50 Ø16	16	100	400	<b>57,18</b>
SAPLUS16	M-16 x 65 Ø20	20	25	100	<b>119,15</b>
SAPLUS20	M-20 x 80 Ø25	25	25	100	<b>465,04</b>

ASK FOR TECHNICAL INFORMATION / DEMANDEZ INFORMATIONS TECHNIQUES / SOLICITENOS LA FICHA TÉCNICA / SOLICITE A FICHA TÉCNICA PARA MAIS INFORMAÇÕES

# JUNIOR-C

**DROP IN ANCHOR, OPTION 7 ETA APPROVED, WITH FLARED LIP**  
 ANCLAJE HEMBRA, HOMOLOGACIÓN ETA, OPCIÓN 7, **CON COLLARÍN**  
 CHEVILLE DE FRAPPE, HOMOLOGUÉE ATE OPTION 7, **AVEC COLLERETTE**  
 BUCHA JUNIOR C/ TACO INT. PARA GRANDES CARGAS, **COM GOLA**

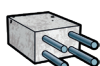
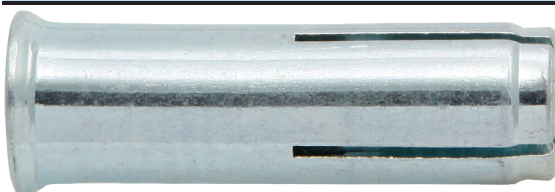

CRACKED CONCRETE / BÉTON FISURÉ / HORMIGÓN FISURADO/BETÃO FISSURADO  
 CONCRETE / BÉTON NON FISURÉ / HORMIGÓN NO FISURADO / BETÃO

European TECHNICAL ASSESSMENT  
**OPTION 1**  
 15/0525

**FB120**

Available in A4

ZINC PLATED / ZINGUÉ / ZINCADO

CODE / CÓDIGO	SIZE / MESURE MEDIDA	BROCA Ø			€ / 100
SAPLUS06C	M-06 x 25 Ø08	8	100	800	<b>15,62</b>
SAPLUS08C	M-08 x 30 Ø10	10	100	800	<b>23,11</b>
SAPLUS10C	M-10 x 40 Ø12	12	100	800	<b>34,54</b>
SAPLUS12C	M-12 x 50 Ø16	16	100	400	<b>68,92</b>
SAPLUS16C	M-16 x 65 Ø20	20	25	100	<b>210,13</b>

ASK FOR TECHNICAL INFORMATION / DEMANDEZ INFORMATIONS TECHNIQUES / SOLICITENOS LA FICHA TÉCNICA / SOLICITE A FICHA TÉCNICA PARA MAIS INFORMAÇÕES

# METAL ANCHORS

CHEVILLES MÉTALLIQUES/ ANCLAJES METÁLICOS/ BUCHAS METÁLICAS

**DROP IN ANCHOR, OPTION 7 ETA APPROVED, STAINLESS STEEL**  
CHEVILLE DE FRAPPE, HOMOLOGUÉE ATE OPTION 7, INOXYDABLE  
ANCLAJE HEMBRA, HOMOLOGACIÓN ETA, OPCIÓN 7, INOXIDABLE  
BUCHA JUNIOR C/ TACO INT. PARA GRANDES CARGAS HOMOLOGADA ETA,OPÇÃO 7, INOXIDÁVEL

## JUNIOR-A

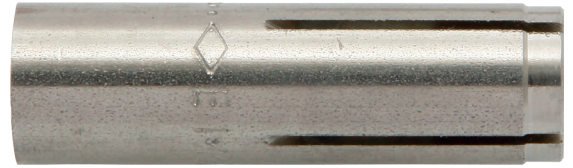
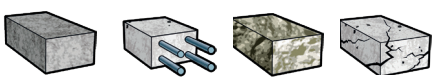

### STAINLESS STEEL A2 - INOXYDABLE A2 - INOX A2

### STAINLESS STEEL A4

CODE / CÓDIGO	SIZE / MESURE MEDIDA	BROCA Ø			€ / 100
JUNIOR00A200006	M-06 x 25 Ø08	8	100	800	<b>42,90</b>
JUNIOR00A200008	M-08 x 30 Ø10	10	100	800	<b>60,45</b>
JUNIOR00A200010	M-10 x 40 Ø12	12	100	800	<b>107,25</b>
JUNIOR00A200012	M-12 x 50 Ø16	16	100	400	<b>185,20</b>
JUNIOR00A200016	M-16 x 65 Ø20	20	25	100	<b>470,00</b>

CODE / CÓDIGO	€ / 100
A4-SAPLUS06	<b>210,68</b>
A4-SAPLUS08	<b>233,23</b>
A4-SAPLUS10	<b>404,45</b>
A4-SAPLUS12	<b>419,57</b>
A4-SAPLUS16	<b>902,33</b>

ASK FOR TECHNICAL INFORMATION / DEMANDEZ INFORMATIONS TECHNIQUES / SOLICITENOS LA FICHA TÉCNICA / SOLICITE A FICHA TÉCNICA PARA MAIS INFORMAÇÕES

### SETTING TOOL FOR DROP IN ANCHORS

OUTIL DE POSE POUR CHEVILLE DE FRAPPE  
EXPANSIONADOR PARA ANCLAJES HEMBRA  
PONTEIRO EXPANSOR PARA BUCHA JUNIOR

## AH-VAR



### ZINC PLATED / ZINGUÉ / ZINCADO

CODE / CÓDIGO	SIZE / MESURE MEDIDA			€ / 100
AHVAR06	FOR M-06	1	1	<b>1.053,50</b>
AHVAR08	FOR M-08	1	1	<b>1.073,10</b>
AHVAR10	FOR M-10	1	1	<b>1.190,70</b>
AHVAR12	FOR M-12	1	1	<b>1.463,00</b>
AHVAR16	FOR M-16	1	1	<b>1.641,50</b>
AHVAR20	FOR M-20	1	1	<b>2.585,10</b>

### SETTING TOOL FOR DROP IN ANCHORS

EXPANSIONADOR PARA ANCLAJES HEMBRA  
OUTIL DE POSE POUR CHEVILLE DE FRAPPE  
PONTEIRO EXPANSOR PARA BUCHA JUNIOR

## AH-MAN



### ZINC PLATED / ZINGUÉ / ZINCADO

CODE / CÓDIGO	SIZE / MESURE MEDIDA			€ / 100
AHMAN06	FOR M-06	1	1	<b>1.653,40</b>
AHMAN08	FOR M-08	1	1	<b>1.855,70</b>
AHMAN10	FOR M-10	1	1	<b>3.320,80</b>
AHMAN12	FOR M-12	1	1	<b>5.542,60</b>
AHMAN16	FOR M-16	1	1	<b>6.226,50</b>
AHMAN20	FOR M-20	1	1	<b>6.769,70</b>

# ANAN 23



SCAFFOLDING ANCHORING, EYE BOLT ZINC PLATED, EYE Ø 23 MM

PITON D'ÉCHAFAUDAGE, ACIER ZINGUÉ, Ø OEILLET 23 MM

ANCLAJE ANDAMIOS. ARGOLLA SOLDADA, ZINCADA, Ø OJO 23 MM

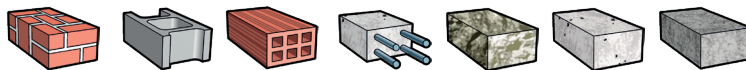
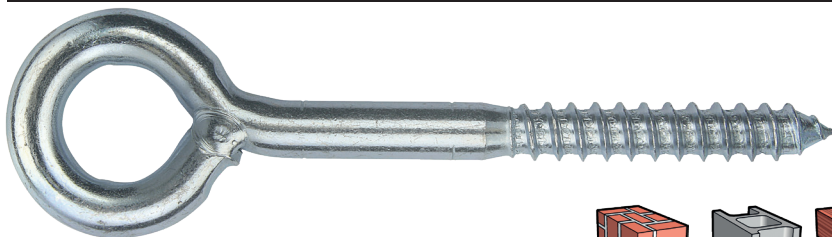
PITON DE ANDAIME, ZINCADO, Ø 23 MM



CODE / CÓDIGO	SIZE / MESURE MEDIDA	EYE / OJO Ø	FOR PLUG Ø POUR CHEVILLE / PARA TACO	HOLE DEPTH MIN. PROF. MIN. TALADRO	MIN. ANCHOR DEPTH PROF. MIN. ANCLAJE			€ / 100
ANAN2309	12 x 90	23	Ø 14 - Ø 16	100	90	20	120	<b>116,77</b>
ANAN2312	12 x 120	23	Ø 14 - Ø 16	130	120	20	80	<b>134,33</b>
ANAN2316	12 x 160	23	Ø 14 - Ø 16	170	160	20	60	<b>165,97</b>
ANAN2319	12 x 190	23	Ø 14 - Ø 16	200	190	20	60	<b>172,12</b>
ANAN2323	12 x 230	23	Ø 14 - Ø 16	240	230	20	40	<b>200,70</b>
ANAN2330	12 x 300	23	Ø 14 - Ø 16	310	300	10	20	<b>253,96</b>
ANAN2335	12 x 350	23	Ø 14 - Ø 16	360	350	10		<b>309,50</b>

ASK FOR TECHNICAL INFORMATION / DEMANDEZ INFORMATIONS TECHNIQUES / SOLICITENOS LA FICHA TÉCNICA / SOLICITE A FICHA TÉCNICA PARA MAIS INFORMAÇÕES

# ANAN 51



SCAFFOLDING ANCHORING, EYE BOLT ZINC PLATED, EYE Ø 51 MM

PITON D'ÉCHAFAUDAGE, ACIER ZINGUÉ, Ø OEILLET 51 MM

ANCLAJE ANDAMIOS. ARGOLLA SOLDADA, ZINCADA, Ø OJO 51 MM

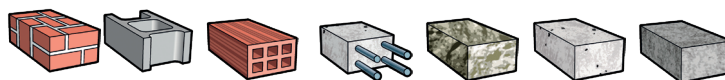
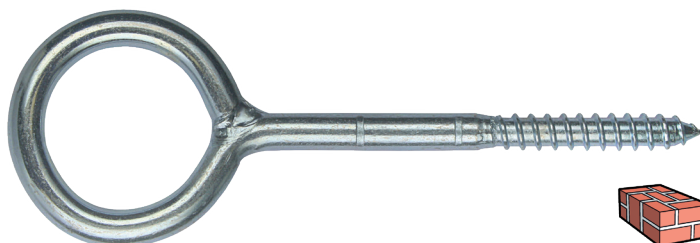
PITON DE ANDAIME, ZINCADO, Ø 51 MM



CODE / CÓDIGO	SIZE / MESURE MEDIDA	EYE / OJO Ø	FOR PLUG Ø POUR CHEVILLE / PARA TACO	HOLE DEPTH MIN. PROF. MIN. TALADRO	MIN. ANCHOR DEPTH PROF. MIN. ANCLAJE			€ / 100
ANAN5114	12 x 140	51	Ø 14 - Ø 16	150	140	20	60	<b>213,36</b>
ANAN5116	12 x 160	51	Ø 14 - Ø 16	170	160	20	40	<b>225,45</b>
ANAN5120	12 x 200	51	Ø 14 - Ø 16	210	200	20	40	<b>290,08</b>
ANAN5124	12 x 240	51	Ø 14 - Ø 16	250	240	20	40	<b>319,55</b>

ASK FOR TECHNICAL INFORMATION / DEMANDEZ INFORMATIONS TECHNIQUES / SOLICITENOS LA FICHA TÉCNICA / SOLICITE A FICHA TÉCNICA PARA MAIS INFORMAÇÕES

# ANANZ 50



EYE BOLT Ø 50 MM, + SHIELD M-10

PITON D'ÉCHAFAUDAGE, Ø OEILLET 50 MM + DOUILLE M-10

ARGOLLA DE FUNDICIÓN, Ø OJO 50 MM + CAPSULA M-10

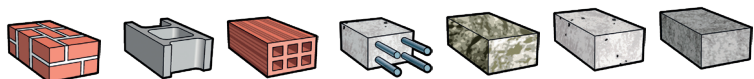
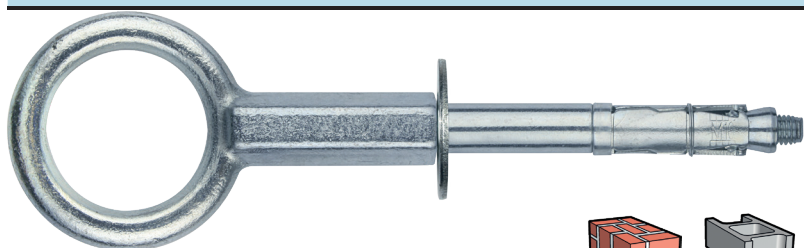
PITON DE ANDAIME Ø50 MM, ZINCADO + BUCHA M-10



CODE / CÓDIGO	SIZE / MESURE MEDIDA	EYE / OJO Ø	HOLE DEPTH MIN. PROF. MIN. TALADRO			€ / 100
ANANZ5021	M-10x210 Ø16	50	130	10	20	<b>656,31</b>

ASK FOR TECHNICAL INFORMATION / DEMANDEZ INFORMATIONS TECHNIQUES / SOLICITENOS LA FICHA TÉCNICA / SOLICITE A FICHA TÉCNICA PARA MAIS INFORMAÇÕES

# METAL ANCHORS

CHEVILLES MÉTALLIQUES/ ANCLAJES METÁLICOS/ BUCHAS METÁLICAS

## TACO DE NYLON, DOS ALAS



NYLON PLUG, TWO WINGS

CHEVILLE NYLON, DEUX AILETTES

BUCHA STANDARD NYLON C/GOLA

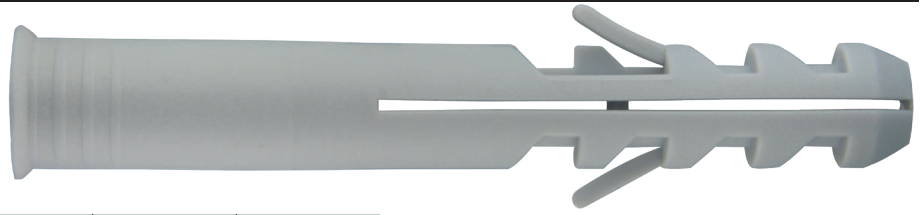
# TN2A



CODE / CÓDIGO	SIZE / MESURE MEDIDA			€ / 100
TN2A14070	14 x 70	20	240	14,77
TN2A14100	14 x 100	20	240	20,34
TN2A14135	14 x 135	20	240	22,24

ASK FOR TECHNICAL INFORMATION / DEMANDEZ INFORMATIONS TECHNIQUES / SOLICITENOS LA FICHA TÉCNICA / SOLICITE A FICHA TÉCNICA PARA MAIS INFORMAÇÕES

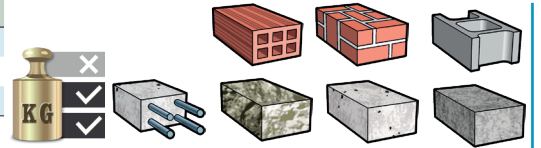

## TACO DE NYLON, OCHO ALAS



NYLON PLUG, EIGHT WINGS

CHEVILLE NYLON, HUIT AILETTES

BUCHA NYLON LONGA C/GOLA

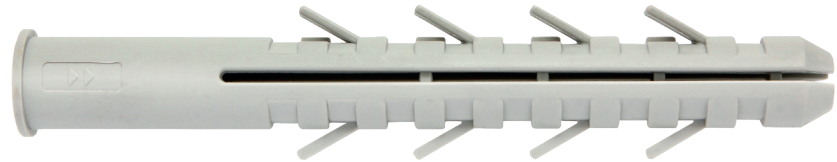
# TN8A



CODE / CÓDIGO	SIZE / MESURE MEDIDA			€ / 100
TN8A14130	14 x 130	20	240	40,73
TN8A14160	14 x 160	20	120	44,80
TN8A16140	16 x 140	20	120	84,70
TN8A16160	16 x 160	20	80	91,61
TN8A16200	16 x 200	20	60	98,84
TN8A16240	16 x 240	20	40	107,28

ASK FOR TECHNICAL INFORMATION / DEMANDEZ INFORMATIONS TECHNIQUES / SOLICITENOS LA FICHA TÉCNICA / SOLICITE A FICHA TÉCNICA PARA MAIS INFORMAÇÕES

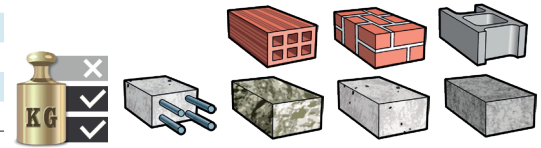



## CAP FOR WALLPLUG HOLES

BOUCHON POUR FORET

TAPÓN PARA TAPAR AGUJEROS

TAMPAS PARA FUROS DOS PITONS DE ADAIMES

# ANANT

CODE / CÓDIGO	SIZE / MESURE MEDIDA	 BROCA Ø			€ / 100
ANANTA40	14 x 40 Ø14	14	100	600	13,86

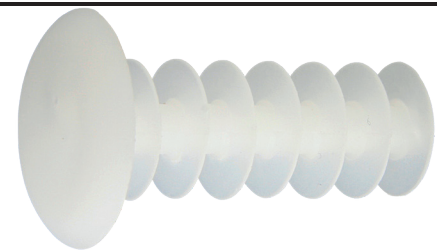

## HWA-HE

HOLLOW WALL ANCHOR FOR USE IN HOLLOW ELEMENTS, **WITH HEX SCREW**

CHEVILLE CORPS CREUX, MONOCORPS, ACIER ZINGUÉ, **AVEC HEX VIS**  
 ANCLAJE HWA, MONOCUERPO, CINCO ALAS, **CON TORNILLO HEXAGONAL**  
 BUCHA TIPO "GUARDA-CHUVA", ZINCADO, **COM PARAFUSO SEXTAVADO**

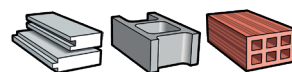

ZINC PLATED / ZINGUÉ / ZINCADO

CODE / CÓDIGO	SIZE / MESURE MEDIDA	BROCA Ø	PAQUETE	CAIXA	€ / 100
HWAHE837	M-08 x 37	14,50	50	400	<b>53,97</b>
HWAHE853	M-08 x 53	14,50	50	400	<b>62,09</b>
HWAHE866	M-08 x 66	14,50	25	200	<b>73,92</b>

ASK FOR TECHNICAL INFORMATION / DEMANDEZ INFORMATIONS TECHNIQUES / SOLICITENOS LA FICHA TÉCNICA / SOLICITE A FICHA TÉCNICA PARA MAIS INFORMAÇÕES

## HWA-CO

HOLLOW WALL ANCHOR FOR USE IN HOLLOW ELEMENTS, **WITH SCREW**

CHEVILLE CORPS CREUX, MONOCORPS, ACIER ZINGUÉ, **AVEC VIS**  
 ANCLAJE HWA, MONOCUERPO, CINCO ALAS, **CON TORNILLO**  
 BUCHA TIPO "GUARDA-CHUVA, ZINCADO", **COM PARAFUSO**

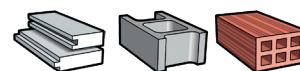

ZINC PLATED / ZINGUÉ / ZINCADO

CODE / CÓDIGO	SIZE / MESURE MEDIDA	BROCA Ø	PAQUETE	CAIXA	€ / 100
HWACO423	M-04 x 23	8	200	3.000	<b>14,56</b>
HWACO435	M-04 x 32	8	100	1.600	<b>14,81</b>
HWACO440	M-04 x 38	8	100	1.600	<b>16,03</b>
HWACO446	M-04 x 45	8	100	800	<b>17,50</b>
HWACO460	M-04 x 54	8	50	800	<b>20,76</b>
HWACO537	M-05 x 37	10	100	800	<b>20,34</b>
HWACO550	M-05 x 52	10	100	800	<b>22,75</b>
HWACO563	M-05 x 65	10	50	400	<b>27,16</b>
HWACO580	M-05 x 80	10	50	400	<b>30,45</b>
HWACO637	M-06 x 37	12	50	800	<b>24,36</b>
HWACO650	M-06 x 52	12	50	400	<b>28,28</b>
HWACO663	M-06 x 65	12	50	400	<b>31,54</b>
HWACO680	M-06 x 80	12	25	400	<b>41,41</b>
HWACO837	M-08 x 37	14,50	50	400	<b>45,50</b>
HWACO853	M-08 x 53	14,50	50	400	<b>59,50</b>
HWACO866	M-08 x 66	14,50	25	200	<b>59,30</b>



ASK FOR TECHNICAL INFORMATION / DEMANDEZ INFORMATIONS TECHNIQUES / SOLICITENOS LA FICHA TÉCNICA / SOLICITE A FICHA TÉCNICA PARA MAIS INFORMAÇÕES

## HWA-SI

HOLLOW WALL ANCHOR FOR USE IN HOLLOW ELEMENTS, **WITHOUT SCREW**

CHEVILLE CORPS CREUX, MONOCORPS, ACIER ZINGUÉ, **SANS VIS**  
 ANCLAJE HWA, MONOCUERPO, CINCO ALAS, **SIN TORNILLO**  
 BUCHA TIPO "GUARDA-CHUVA", ZINCADO, **SEM PARAFUSO**

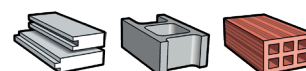

ZINC PLATED / ZINGUÉ / ZINCADO

CODE / CÓDIGO	SIZE / MESURE MEDIDA	BROCA Ø	PAQUETE	CAIXA	€ / 100
HWASI435	M-04 x 32	8	100	1.500	<b>13,90</b>
HWASI537	M-05 x 37	10	100	800	<b>16,38</b>
HWASI550	M-05 x 52	10	100	800	<b>19,22</b>
HWASI563	M-05 x 65	10	50	400	<b>21,32</b>
HWASI637	M-06 x 37	12	50	800	<b>19,85</b>
HWASI650	M-06 x 52	12	50	400	<b>24,26</b>
HWASI663	M-06 x 65	12	50	400	<b>27,13</b>
HWASI837	M-08 x 37	14,50	100	800	<b>38,50</b>
HWASI853	M-08 x 53	14,50	50	400	<b>43,40</b>
HWASI866	M-08 x 66	14,50	50	400	<b>47,18</b>



ASK FOR TECHNICAL INFORMATION / DEMANDEZ INFORMATIONS TECHNIQUES / SOLICITENOS LA FICHA TÉCNICA / SOLICITE A FICHA TÉCNICA PARA MAIS INFORMAÇÕES

# METAL ANCHORS

CHEVILLES MÉTALLIQUES/ ANCLAJES METÁLICOS/ BUCHAS METÁLICAS

## SETTING TOOL FOR HOLLOW WALL ANCHOR

OUTIL DE POSE POUR CHEVILLES CORPS CREUX  
PISTOLA PARA ANCLAJE HWA  
PISTOLA PARA BUCHA TIPO "GUARDA-CHUVA"

# HWA



CODE / CÓDIGO	SIZE / MESURE MEDIDA			€ / 100
HWAPISTO	GUN / PISTOLA	1	25	1.715,00

## ANCHOR FOR PLASTERBOARD PANELS, NYLON, POLYAMIDE 6.6

CHEVILLE POUR PLAQUES DE PLÂTRE, NYLON, POLYAMIDE 6.6  
TACO PARA PLACAS DE CARTÓN-YESO, NYLON, POLIAMIDA 6.6  
BUCHA A.PERF. PARA GESSO CARTONADO, NYLON, POLIDO 6.6

# TAPLA-N



CODE / CÓDIGO	SIZE / MESURE MEDIDA	↓ MAX. ↑			€ / 100
TAPLA1233	12 x 33	9 - 16	100	1.600	7,95

ASK FOR TECHNICAL INFORMATION / DEMANDEZ INFORMATIONS TECHNIQUES / SOLICITENOS LA FICHA TÉCNICA / SOLICITE A FICHA TÉCNICA PARA MAIS INFORMAÇÕES



## ANCHOR FOR PLASTERBOARD PANELS, ZAMAK, WITH SCREW

CHEVILLE POUR PLAQUES DE PLÂTRE, ZAMAK, AVEC VIS  
TACO PARA PLACAS DE CARTÓN-YESO, ZAMAK, CON TORNILLO  
BUCHA A.PERF. PARA GESSO CARTONADO, ZAMAK, COM PARAFUSO

# TAPLA-ZP



CODE / CÓDIGO	SIZE / MESURE MEDIDA	TORNILLO SCREW / VIS	↓ MAX. ↑			€ / 100
TAPLA1332	13 x 32	4,2 x 32	9 - 16	100	1.600	15,68

ASK FOR TECHNICAL INFORMATION / DEMANDEZ INFORMATIONS TECHNIQUES / SOLICITENOS LA FICHA TÉCNICA / SOLICITE A FICHA TÉCNICA PARA MAIS INFORMAÇÕES



## ANCHOR FOR PLASTERBOARD PANELS, ZAMAK

CHEVILLE POUR PLAQUES DE PLÂTRE, ZAMAK  
TACO PARA PLACAS DE CARTÓN-YESO, ZAMAK  
BUCHA A.PERF. PARA GESSO CARTONADO, ZAMAK

# TAPLA-Z



CÓDIGO CODE	SIZE / MESURE MEDIDA	↓ MAX. ↑			€ / 100
TAPLA1337	13 x 37	9 - 16	100	1.600	17,74

ASK FOR TECHNICAL INFORMATION / DEMANDEZ INFORMATIONS TECHNIQUES / SOLICITENOS LA FICHA TÉCNICA / SOLICITE A FICHA TÉCNICA PARA MAIS INFORMAÇÕES



## NYLON PLUG, FOR PLASTERBOARD PANEL WALLS

CHEVILLE NYLON, POUR PLAQUES DE CARTÓN-PLÂTRE  
TACO DE NYLON, PARA PLACAS DE CARTÓN YESO Y CAVIDADES  
BUCHA NYLON HAV, PARA PLACAS DE GESSO CARTONADO

# TANCORA

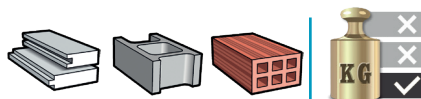

CODE / CÓDIGO	SIZE / MESURE MEDIDA	↓ MAX. ↑			€ / 100
TANCORA40	10 x 40 Ø 10	4 - 12	100	600	7,39
TANCORA47	10 x 47 Ø 10	15 - 19	100	600	8,65

ASK FOR TECHNICAL INFORMATION / DEMANDEZ INFORMATIONS TECHNIQUES / SOLICITENOS LA FICHA TÉCNICA / SOLICITE A FICHA TÉCNICA PARA MAIS INFORMAÇÕES

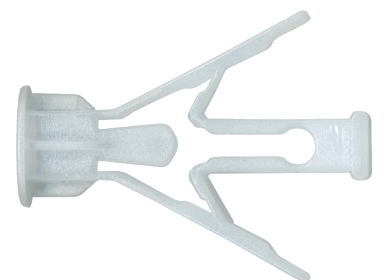

## MRR

COUPLING NUT, ROUND, ZINC PLATED

RACCORD DE JONCTION, ZINGUÉ BLANC

MANGUITO DE UNIÃO ROSCADO, REDONDO, ZINCADO

UNIÃO SEXTAVADA CILINDRICA, ZINCADO



ZINC PLATED / ZINGUÉ / ZINCADO

CODE / CÓDIGO	SIZE / MESURE MEDIDA	Ø			€ / 100
MRRZ5322	5/32W x 20	7	200	4.800	<b>13,07</b>
MRRZ0420	M-04 x 20	7	200	4.800	<b>8,30</b>
MRRZ0620	M-06 x 20	10	200	2.400	<b>9,83</b>
MRRZ0630	M-06 x 30	10	200	2.400	<b>11,21</b>
MRRZ0825	M-08 x 25	11	200	2.400	<b>10,32</b>
MRRZ0830	M-08 x 30	11	200	2.400	<b>11,95</b>
MRRZ1030	M-10 x 30	13	150	900	<b>16,63</b>
MRRZ1235	M-12 x 35	15	100	600	<b>25,05</b>
MRRZ1650	M-16 x 50	22	50	300	<b>88,62</b>

ASK FOR TECHNICAL INFORMATION / DEMANDEZ INFORMATIONS TECHNIQUES / SOLICITENOS LA FICHA TÉCNICA / SOLICITE A FICHA TÉCNICA PARA MAIS INFORMAÇÕES

## MRH

COUPLING NUT, HEXAGONAL

RACCORD DE JONCTION, HEXAGONALE

MANGUITO DE UNIÃO ROSCADO, HEXAGONAL

UNIÃO SEXTAVADA



ZINC PLATED / ZINGUÉ / ZINCADO

CODE / CÓDIGO	SIZE / MESURE MEDIDA				€ / 100
00633405ZN00005	M-05 x 15	08	100	2.400	<b>4,55</b>
MRHZ0620	M-06 x 20	10	200	2.400	<b>4,85</b>
MRHZ0630	M-06 x 30	10	200	2.400	<b>4,97</b>
MRHZ0825	M-08 x 25	11	200	2.400	<b>7,45</b>
MRHZ1030	M-10 x 30	13	150	900	<b>16,60</b>
MRHZ1235	M-12 x 35	17	100	600	<b>20,70</b>
MRHZ1650	M-16 x 50	24	50	300	<b>49,68</b>
MRHZ2060	M-20 x 60	30	25	150	<b>124,20</b>

STAINLESS STEEL A2 - INOX A2

CODE / CÓDIGO	€ / 100
006334A27000006	<b>42,49</b>
006334A27000008	<b>52,50</b>
006334A27000010	<b>105,00</b>
006334A27000012	<b>140,00</b>
006334A27000016	<b>396,00</b>

## TLAT

BRASS ANCHOR, FOR LIGHT FASTENINGS

CHEVILLE LAITON, POUR FIXATIONS LÉGÈRES

TACO DE LATÓN, PARA CARGAS LIGERAS

BUCHA DE LATÃO, PARA CARGAS LIGEIRAS

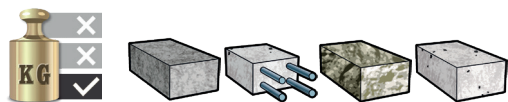
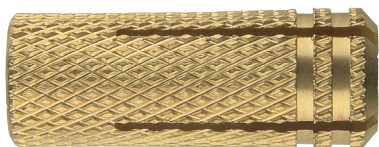

BRASS / LAITON / LATÓN / LATÃO

CODE / CÓDIGO	SIZE / MESURE MEDIDA	Ø			€ / 100
TLAT532	5/32 W x 16	5	300	9.600	<b>6,41</b>
TLATM04	M-04 x 16	5	300	9.600	<b>6,34</b>
TLATM05	M-05 x 18	6	200	6.400	<b>10,89</b>
TLATM06	M-06 x 23	8	200	4.800	<b>14,67</b>
TLATM08	M-08 x 28	10	100	2.400	<b>26,04</b>
TLATM10	M-10 x 33	12	150	1.800	<b>40,99</b>
TLATM12	M-12 x 38	15	150	900	<b>90,44</b>

ASK FOR TECHNICAL INFORMATION / DEMANDEZ INFORMATIONS TECHNIQUES / SOLICITENOS LA FICHA TÉCNICA / SOLICITE A FICHA TÉCNICA PARA MAIS INFORMAÇÕES

## TARAS

EXPRESS NAIL

CHEVILLE POUR FIXATION DE LITEAUX

TACO PARA LA FIJACIÓN DE RASTRELES

CAVILHA DE SOALHO

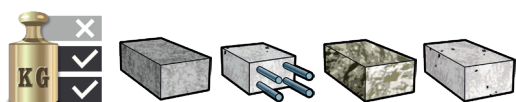
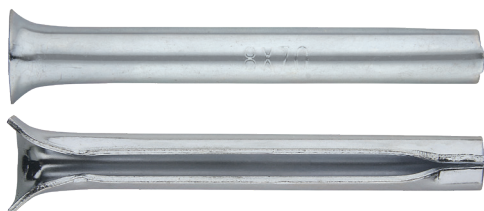

ZINC PLATED / ZINGUÉ / ZINCADO

CODE / CÓDIGO	SIZE / MESURE MEDIDA	↓ MAX. ↑			€ / 100
TARAS6050	6 x 50	20	200	2.400	<b>9,10</b>
TARAS6060	6 x 60	30	200	1.200	<b>11,43</b>
TARAS6080	6 x 80	50	200	1.200	<b>12,24</b>
TARAS8070	8 x 70	30	100	1.200	<b>16,89</b>
TARAS8090	8 x 90	50	100	600	<b>19,80</b>
TARAS8110	8 x 110	70	100	600	<b>23,08</b>
TARAS8130	8 x 130	90	100	600	<b>25,26</b>
TARAS8150	8 x 150	110	100	600	<b>28,39</b>

ASK FOR TECHNICAL INFORMATION / DEMANDEZ INFORMATIONS TECHNIQUES / SOLICITENOS LA FICHA TÉCNICA / SOLICITE A FICHA TÉCNICA PARA MAIS INFORMAÇÕES



European Import Group

**CHEMICAL ANCHOR**  
CHEVILLES ANÇORS  
ANCLAJES QUÍMICOS  
FIXAÇÃO QUÍMICA

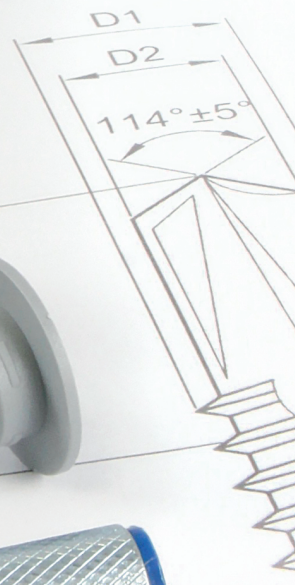
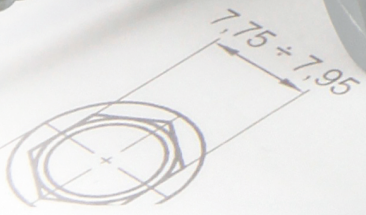
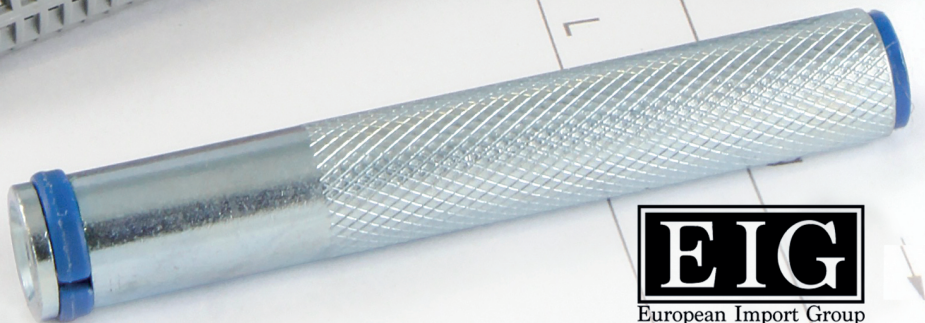

Family: TS



## AQ

GUNS NOZZLES & ACESSORIES  
PISTOLETS CANULES MÉLAGEUSES  
PISTOLAS CÁNULAS & ACCESORIOS  
PISTOLAS BOQUILHAS & ACESSÓRIOS



CODE / CÓDIGO	SIZE / MESURE / MEDIDA	PRICE	€ / 100
AQPIMAN	MANUAL GUN	1	<b>2.688,00</b>
AQPIPRO	PROFESSIONAL GUN 410 ml	1	<b>6.569,00</b>
AQPISIL	SILICONE GUN 300 ml	1	<b>1.323,00</b>
AQBOMBA	BLOWING PUMP	1	<b>864,50</b>
AQCANULA	NOZZLE 300 - 410 ml	1	<b>63,84</b>
MPM0010	NOZZLE 300 - 410 ml (PACK 10Un)	10	<b>60,00</b>
AQKITCEP	BRUSH KIT	1	<b>6.582,00</b>

## AQTN

PLASTIC SLEEVE  
TAMIS PLASTIQUE  
TAMIZ PLÁSTICO  
CAMISA NYLON

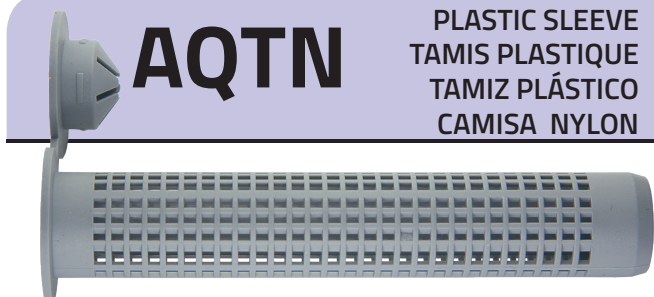

CODE / CÓDIGO	SIZE / MESURE / MEDIDA	PRICE	€ / 100
AQTN12050	12 x 50	12	<b>24,92</b>
AQTN16085	15 x 85	12	<b>20,86</b>
AQTN16130	15 x 130	12	<b>24,36</b>
AQTN20085	20 x 85	12	<b>23,52</b>

## AQTR

SLEEVE INTERNAL THREAD  
DOUILLE FEMELLE  
TAMIZ ROSCADO  
CAMISA METÁLICA

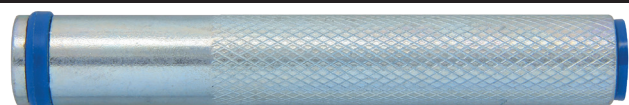

ZINC PLATED / ZINGUÉ / ZINCADO

CODE / CÓDIGO	SIZE / MESURE / MEDIDA	PRICE	€ / 100
AQTR08	M-08 x 80 Ø12	12	<b>109,44</b>
AQTR10	M-10 x 80 Ø14	12	<b>122,15</b>
AQTR12	M-12 x 80 Ø16	12	<b>151,16</b>

## PBQ

STUD BOLTS  
TIGES FILETÉES  
ESPÁRRAGOS ROSCADOS  
PERNO PARA BUCHA QUÍMICA

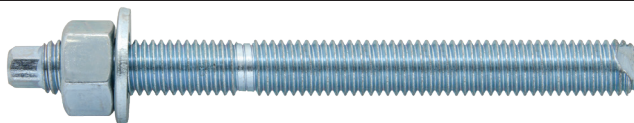

STEEL 5.8-8.8 ZINC PLATED / STAINLESS STEEL A2 - A4

CODE / CÓDIGO	SIZE	PRICE	Class	€ / 100
PERNOBQ58Z06070	M-06 x 070		5.8	<b>44,65</b>
PERNOBQ58Z08110	M-08 x 110		5.8	<b>47,65</b>
PERNOBQ58Z10115	M-10 x 115		5.8	<b>49,90</b>
PERNOBQ58Z10130	M-10 x 130		5.8	<b>54,45</b>
PERNOBQ58Z12110	M-12 x 110		5.8	<b>58,50</b>
PERNOBQ58Z12160	M-12 x 160		5.8	<b>61,27</b>
PERNOBQ58Z16190	M-16 x 190		5.8	<b>95,31</b>
PERNOBQ58Z20260	M-20 x 260		5.8	<b>190,63</b>
PERNOBQ58Z24300	M-24 x 300		5.8	<b>374,46</b>
PERNOBQ58Z30380	M-30 x 380		5.8	<b>1.021,28</b>
PERNOBQ88Z08110	M-08 x 110		8.8	<b>68,24</b>
PERNOBQ88Z10130	M-10 x 130		8.8	<b>81,89</b>
PERNOBQ88Z12160	M-12 x 160		8.8	<b>95,54</b>
PERNOBQ88Z16190	M-16 x 190		8.8	<b>163,79</b>
PERNOBQ88Z20260	M-20 x 260		8.8	<b>354,89</b>
PERNOBQ88Z24300	M-24 x 300		8.8	<b>682,49</b>
PERNOBQ88Z30380	M-30 x 380		8.8	<b>1.910,99</b>
PERNOBQA208110	M-08 x 110		INOX A2	<b>63,86</b>
PERNOBQA210130	M-10 x 130		INOX A2	<b>118,99</b>
PERNOBQA212160	M-12 x 160		INOX A2	<b>199,49</b>
PERNOBQA216190	M-16 x 190		INOX A2	<b>365,74</b>
PERNOBQA220260	M-20 x 260		INOX A2	<b>839,99</b>
PERNOBQA224300	M-24 x 300		INOX A2	<b>1.382,49</b>
PERNOBQA230380	M-30 x 380		INOX A2	<b>2.712,49</b>
PERNOBQA408110	M-08 x 110		INOX A4	<b>68,08</b>
PERNOBQA410130	M-10 x 130		INOX A4	<b>147,51</b>
PERNOBQA412160	M-12 x 160		INOX A4	<b>226,94</b>
PERNOBQA416190	M-16 x 190		INOX A4	<b>425,53</b>
PERNOBQA420260	M-20 x 260		INOX A4	<b>851,06</b>
PERNOBQA424300	M-24 x 300		INOX A4	<b>1.418,44</b>
PERNOBQA430380	M-30 x 380		INOX A4	<b>2.836,91</b>

## AQTM

METAL SLEEVE  
TAMIS MÉTALLIQUE  
TAMIZ METÁLICO  
MANGA METÁLICA

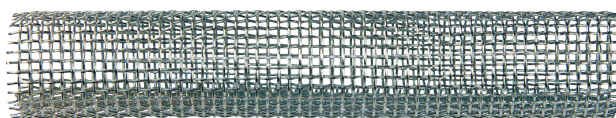

CODE / CÓDIGO	SIZE / MESURE / MEDIDA	PRICE	€ / 100
AQTM12100	12 x 1000	10	<b>1.000,30</b>
AQTM16100	16 x 1000	5	<b>1.165,50</b>
AQTM22100	22 x 1000	5	<b>1.323,00</b>

# EIG









European Import Group

## 3

**NYLON ANCHORS**  
**CHEVILLES NYLON**  
**ANCLAJES NYLON**  
**BUCHAS NYLON**



**MATERIALS / MATÉRIAUX / MATERIALES / MATERIAIS:**

- |  |   |   |   |   |   |   |   |  |
|--|---|---|---|---|---|---|---|--|
|  |  |  |  |  |  |          |  |       |
| CONCRETE<br>BÉTON<br>HORMIGÓN<br>BETÃO   | REINFORCED CONCRETE<br>BÉTON ARMÉ<br>HORMIGÓN ARMADO<br>BETÃO ARMADO                | STONE<br>PIERRE<br>PIEDRA<br>PEDRA  | SOLID BRICK<br>BRIQUE PLEINE<br>LADRILLO MACIZO<br>TIJOLO MACIÇO                    | REFRACTORY BRICK<br>BRIQUES RÉFRACTAIRES<br>LADRILLO DE ADOBE<br>TIJOLO REFRAATÁRIO | LIGHTWEIGHT CONCRETE<br>BÉTON LÉGER<br>HORMIGÓN LIGERO<br>BETÃO LEVE                | HOLLOW CONCRETE BLOCK<br>BLOC DE BÉTON CREUX<br>BLOQUE HUECO HORMIGÓN<br>BLOCO DE BETÃO OCO | HOLLOW BRICK<br>BRIQUE CREUSE<br>LADRILLO HUECO<br>TIJOLO OCO                       | LAMINATED GYPSUM PANEL<br>PANNEAU DE GYPSE LAMINÉ<br>PANEL YESO LAMINADO<br>PLACA DE GESSO |
|  |  |  |  |  |  |          |  |       |
| STEEL PIPE<br>TUBE D'ACIER<br>TUBO DE ACERO<br>TUBO DE AÇO                         | COPPER TUBE<br>TUBE DE CUIVRE<br>TUBO DE COBRE<br>TUBO DE COBRE                     | PVC TUBE<br>TUBE EN PVC<br>TUBO DE PVC<br>TUBO DE PVC                               | FLEXIBLE TUBE<br>TUBE FLEXIBLE<br>TUBO FLEXIBLE<br>TUBO FLEXIVEL                    | CABLE<br>CÂBLE<br>CABLE<br>CABO   |   |   |   |  |

# EIG



## NYLON PLUG, FOUR EXPANSIONS, POLYAMIDE 6.6

CHEVILLE NYLON, QUADRUPLE EXPANSION, POLYAMIDE 6.6

TACO DE NYLON, CUATRO EXPANSIONES, POLIAMIDA 6.6

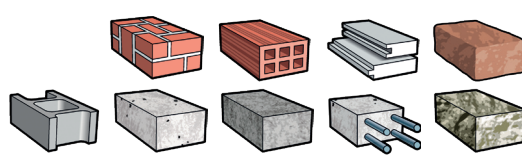
BUCHA NYLON UNIVERSAL, QUATRO PONTOS EXPANSÃO, C/GOLA, POLIAMIDA 6.6



CODE / CÓDIGO	SIZE / MESURE MEDIDA	DRILL / PERÇAGE BROCA A UTILIZAR	HOLE DEPTH MIN. PROF. MÍNIMA BROCA	SCREW / VIS TORNILLO A UTILIZAR			€ / 100
TGX0525	Ø 5 x 25	Ø 5	35	Ø 2,5 - 4,0	100	4.800	<b>0,84</b>
TGX0630	Ø 6 x 30	Ø 6	45	Ø 3,5 - 4,0	100	3.200	<b>0,88</b>
TGX0840	Ø 8 x 40	Ø 8	55	Ø 4,5 - 6,0	100	1.600	<b>1,70</b>
TGX0850	Ø 8 x 50	Ø 8	65	Ø 4,5 - 6,0	100	1.600	<b>3,81</b>
TGX1050	Ø 10 x 50	Ø 10	65	Ø 6,0 - 8,0	50	800	<b>3,29</b>
TGX1260	Ø 12 x 60	Ø 12	80	Ø 8,0 - 10,0	25	400	<b>14,28</b>
TGX1470	Ø 14 x 70	Ø 14	90	Ø 10,0 - 12,0	20	320	<b>18,02</b>

ASK FOR TECHNICAL INFORMATION / DEMANDEZ INFORMATIONS TECHNIQUES / SOLICITENOS LA FICHA TÉCNICA / SOLICITE A FICHA TÉCNICA PARA MAIS INFORMAÇÕES

# EIG-BP



CODE / CÓDIGO	SIZE / MESURE MEDIDA		€ / 1 PC
TGX0630BP	Ø 6 x 30	1.000	<b>32,10</b>
TGX0840BP	Ø 8 x 40	500	<b>25,60</b>
TGX1050BP	Ø 10 x 50	300	<b>27,55</b>

# TANUDO



## UNIVERSAL PLUG WITH COLLAR

CHEVILLE UNIVERSELLE AVEC COLLERETE, TYPE NOEUD

TACO NUDO, UNIVERSAL CON COLLARÍN, POLIAMIDA 6.6

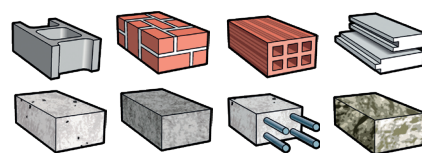
BUCHA DE NYLON UNIVERSAL PARA TIJOLO C/GOLA, POLIAMIDA 6.6



CODE / CÓDIGO	SIZE / MESURE MEDIDA	PARA TORNILLO FOR SCREW / POUR VIS	↓ MAX. ↑			€ / 100
TANUDO06	6 x 35	TPO Ø 3,5 - 4,0	10	150	2.400	<b>1,20</b>
TANUDO08	8 x 50	TPO Ø 4,0 - 4,5	12	80	1.200	<b>2,51</b>
TANUDO10	10 x 60	TPO Ø 5,0 - 6,0	11	50	800	<b>4,48</b>

ASK FOR TECHNICAL INFORMATION / DEMANDEZ INFORMATIONS TECHNIQUES / SOLICITENOS LA FICHA TÉCNICA / SOLICITE A FICHA TÉCNICA PARA MAIS INFORMAÇÕES

# NYLON ANCHORS

CHEVILLES NYLON / ANCLAJES NYLON / BUCHAS NYLON

## NYLON PLUG, POLYAMIDE 6.6

CHEVILLE NYLON, POLYAMIDE 6.6

TACO DE NYLON, POLIAMIDA 6.6

BUCHA NYLON STANDARD, POLIAMIDA 6.6

# TANY

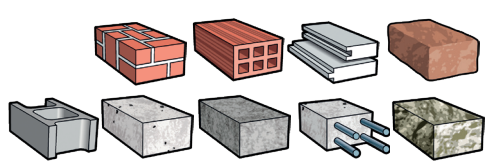

CODE / CÓDIGO	SIZE / MESURE MEDIDA	DRILL / PERÇAGE BROCA A UTILIZAR	HOLE DEPTH MIN. PROF. MÍNIMA BROCA	SCREW / VIS TORNILLO A UTILIZAR			€ / 100
TANY04	Ø 4 x 20	Ø 4	25	Ø 2,0 - 3,0	200	21.600	<b>0,55</b>
TANY05	Ø 5 x 25	Ø 5	35	Ø 2,5 - 4,0	150	16.200	<b>0,55</b>
TANY06	Ø 6 x 30	Ø 6	40	Ø 3,5 - 4,0	100	10.800	<b>0,60</b>
TANY07	Ø 7 x 30	Ø 7	40	Ø 4,0 - 4,5	100	5.000	<b>1,88</b>
TANY08	Ø 8 x 40	Ø 8	50	Ø 4,5 - 6,0	100	5.000	<b>1,18</b>
TANY10	Ø 10 x 50	Ø 10	65	Ø 6,0 - 8,0	50	2.500	<b>2,23</b>
TANY12	Ø 12 x 60	Ø 12	75	Ø 8,0 - 10,0	25	1.250	<b>3,99</b>
TANY14	Ø 14 x 70	Ø 14	90	Ø 10,0 - 12,0	20	1.000	<b>8,95</b>
TANY16	Ø 16 x 80	Ø 16	95	Ø 12,0 - 14,0	10	500	<b>39,75</b>

## BULK / GRANDE BOÎTE / GRANEL

CODE / CÓDIGO	SIZE / MESURE MEDIDA		€ / 100
TANY05GR	Ø 5 x 25	15.000	<b>0,48</b>
TANY06GR	Ø 6 x 30	10.000	<b>0,50</b>
TANY08GR	Ø 8 x 40	5.000	<b>0,97</b>
TANY10GR	Ø 10 x 50	2.000	<b>2,04</b>
TANY12GR	Ø 12 x 60	1.500	<b>3,15</b>
TANY14GR	Ø 14 x 70	1.000	<b>10,04</b>



## NYLON PLUG WITH COLLAR, POLYAMIDE 6.6

CHEVILLE NYLON AVEC COLLERETTE, POLYAMIDE 6.6

TACO DE NYLON CON COLLARÍN, POLIAMIDA 6.6

BUCHA NYLON STANDARD C/GOLA, POLIAMIDA 6.6

# TANYCO

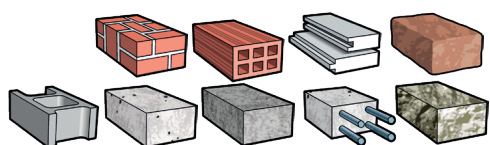

CODE / CÓDIGO	SIZE / MESURE MEDIDA	DRILL / PERÇAGE BROCA A UTILIZAR	HOLE DEPTH MIN. PROF. MÍNIMA BROCA	SCREW / VIS TORNILLO A UTILIZAR			€ / 100
TANYCO05	Ø 5 x 25	Ø 5	35	Ø 2,5 - 4,0	150	16.200	<b>0,55</b>
TANYCO06	Ø 6 x 30	Ø 6	40	Ø 3,5 - 4,0	100	10.800	<b>0,60</b>
TANYCO08	Ø 8 x 40	Ø 8	50	Ø 4,5 - 6,0	100	5.000	<b>1,18</b>
TANYCO10	Ø 10 x 50	Ø 10	65	Ø 6,0 - 8,0	50	2.500	<b>2,23</b>
TANYCO12	Ø 12 x 60	Ø 12	75	Ø 8,0 - 10,0	25	1.250	<b>3,99</b>

## PLASTIC PLUG, POLYPROPYLENE

TACO PLÁSTICO BLANCO, POLIPROPILENO

CHEVILLE PLASTIQUE, POLYPROPYLÈNE

BUCHA PLÁSTICA, POLIPROPILENO

# TAPRO

CODE / CÓDIGO	SIZE / MESURE MEDIDA			€ / 100
TAPRO05	Ø 5 x 20	25	1.000	<b>1,25</b>
TAPRO06	Ø 6 x 22	25	1.000	<b>1,40</b>
TAPRO07	Ø 7 x 23	25	1.000	<b>1,55</b>
TAPRO08	Ø 8 x 25	25	1.000	<b>1,68</b>
TAPRO09	Ø 9 x 30	25	1.000	<b>2,36</b>
TAPRO10	Ø 10 x 40	25	1.000	<b>3,25</b>
TAPRO12	Ø 12 x 50	25	1.000	<b>5,26</b>
TAPRO14	Ø 14 x 50	25	1.000	<b>6,94</b>

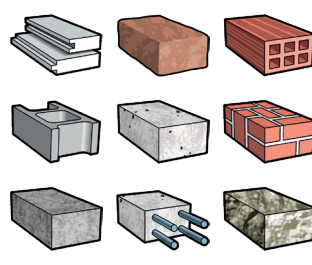

## TNCA COUNTERSUNK HEAD

HAMMERFIX ANCHOR, POLYAMIDE 6.6, COUNTERSUNK HEAD  
CHEVILLE À FRAPPER, POLYAMIDE 6.6, TÊTE FRAISÉE  
TACO CLAVABLE DE NYLON PREMONTADO, POLIAMIDA 6.6, CABEZA AVELLANADA  
TAPITS NYLON, POLIAMIDA 6.6, CABEÇA DE EMBEBER

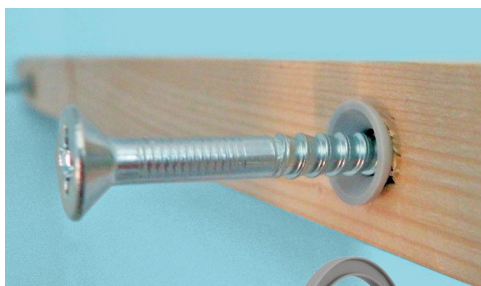
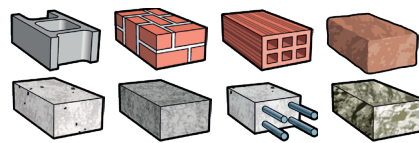

CODE / CÓDIGO	SIZE / MESURE MEDIDA		↓ MAX. ↑			€ / 100
TNCA05025	5 x 25	PZ2	5	100	2.400	3,60
TNCA05030	5 x 30	PZ2	5	100	2.400	3,64
TNCA05035	5 x 35	PZ2	10	100	2.400	4,42
TNCA05050	5 x 50	PZ2	25	100	1.600	5,14
TNCA06035	6 x 35	PZ2	10	100	1.600	4,84
TNCA06040	6 x 40	PZ2	10	100	1.600	4,87
TNCA06050	6 x 50	PZ2	20	100	1.600	6,05
TNCA06060	6 x 60	PZ2	30	100	1.600	6,62
TNCA06070	6 x 70	PZ2	40	100	1.600	7,66
TNCA06080	6 x 80	PZ2	50	100	600	9,44
TNCA08060	8 x 60	PZ3	20	100	600	10,37
TNCA08080	8 x 80	PZ3	40	100	600	12,67
TNCA08100	8 x 100	PZ3	60	100	600	14,94
TNCA08120	8 x 120	PZ3	80	100	400	18,22
TNCA08140	8 x 140	PZ3	100	100	300	29,32

ASK FOR TECHNICAL INFORMATION / DEMANDEZ INFORMATIONS TECHNIQUES / SOLICITENOS LA FICHA TÉCNICA / SOLICITE A FICHA TÉCNICA PARA MAIS INFORMAÇÕES

### CLAVABLE TACO IN PLASTIC BOTTE

CÓDIGO CODE	SIZE / MESURE MEDIDA		↓ MAX. ↑		€ / 1 PC
TNCA05030BP	5 x 30	PZ2	5	750	40,85
TNCA06040BP	6 x 40	PZ2	10	500	34,25

## TNCC CYLINDRICAL HEAD

TACO CLAVABLE DE NYLON PREMONTADO, POLIAMIDA 6.6, CABEZA CILÍNDRICA  
HAMMERFIX ANCHOR, POLYAMIDE 6.6, CYLINDRICAL HEAD  
CHEVILLE À FRAPPER, POLYAMIDE 6.6, TÊTE CYLINDRIQUE  
TAPITS NYLON, POLIAMIDA 6.6, CABEÇA CILÍNDRICA

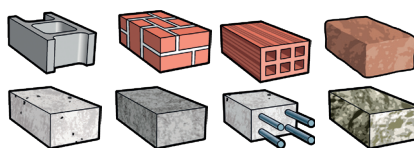

CODE / CÓDIGO	SIZE / MESURE MEDIDA		↓ MAX. ↑			€ / 100
TNCC05025	5 x 25	PZ2	5	100	2.400	3,78
TNCC05030	5 x 30	PZ2	5	100	2.400	3,84
TNCC05035	5 x 35	PZ2	10	100	2.400	4,65
TNCC05050	5 x 50	PZ2	25	100	1.600	5,41
TNCC06035	6 x 35	PZ2	10	100	1.600	5,10
TNCC06040	6 x 40	PZ2	10	100	1.600	5,12
TNCC06050	6 x 50	PZ2	20	100	1.600	6,40
TNCC06060	6 x 60	PZ2	30	100	1.600	6,97
TNCC06070	6 x 70	PZ2	40	100	1.600	8,10
TNCC08060	8 x 60	PZ3	20	100	600	10,91
TNCC08080	8 x 80	PZ3	40	100	600	13,33
TNCC08100	8 x 100	PZ3	60	100	600	15,27
TNCC08120	8 x 120	PZ3	80	100	400	19,18
TNCC08140	8 x 140	PZ3	100	100	300	21,61

ASK FOR TECHNICAL INFORMATION / DEMANDEZ INFORMATIONS TECHNIQUES / SOLICITENOS LA FICHA TÉCNICA / SOLICITE A FICHA TÉCNICA PARA MAIS INFORMAÇÕES

# NYLON ANCHORS

CHEVILLES NYLON / ANCLAJES NYLON / BUCHAS NYLON

**HAMMERFIX ANCHOR, POLYAMIDE 6.6, COUNTERSUNK HEAD SS A2**

CHEVILLE À FRAPPER, POLYAMIDE 6.6, TÊTE FRAISÉE, INOX A2

HACO CLAVABLE DE NYLON PREMONTADO, POLIAMIDA 6.6, CABEZA AVELLANADA, INOX A2

TAPITS NYLON, POLIAMIDA 6.6, CABEÇA EMBEBER, INOX A2

**TNCAI**  
**COUNTERSUNK HEAD SS A2**

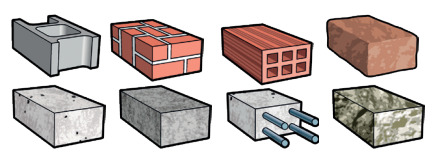

CODE / CÓDIGO	SIZE / MESURE MEDIDA		↓ MAX. ↑			€ / 100
TNCAI05030	5 x 30	PZ2	5	100	2.400	<b>16,63</b>
TNCAI06040	6 x 40	PZ2	10	100	1.200	<b>25,31</b>
TNCAI06060	6 x 60	PZ2	30	100	1.200	<b>31,47</b>
TNCAI08060	8 x 60	PZ3	20	100	600	<b>49,56</b>
TNCAI08080	8 x 80	PZ3	40	100	600	<b>58,17</b>
TNCAI08100	8 x 100	PZ3	60	100	600	<b>72,07</b>

**HAMMERFIX ANCHOR SIX WINGS, POLYAMIDE 6.6, COUNTERSUNK HEAD**

TACO DE NYLON 6 ALAS, POLIAMIDA 6.6, CABEZA AVELLANADA

CHEVILLE SIX AILETTES, POLYAMIDE 6.6, TÊTE FRAISÉE

TAPITS NYLON, POLIDA, LONGAS, POLIDA 6.6, CABEÇA EMBEBER

**TN6A**  
**COUNTERSUNK HEAD**

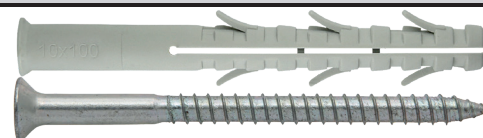
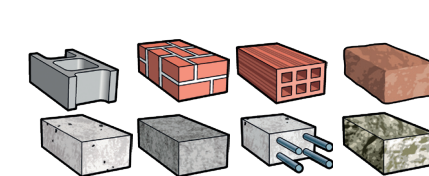

CODE / CÓDIGO	SIZE / MESURE MEDIDA	↓ MAX. ↑			€ / 100
TN6A08080	8 x 80	15	100	600	<b>26,80</b>
TN6A08100	8 x 100	35	100	400	<b>31,01</b>
TN6A08120	8 x 120	55	100	400	<b>36,65</b>
TN6A10100	10 x 100	25	100	300	<b>44,02</b>
TN6A10120	10 x 120	40	100	300	<b>54,70</b>
TN6A10140	10 x 140	60	100	300	<b>57,60</b>
TN6A10160	10 x 160	85	100	200	<b>68,90</b>
TN6A10200	10 x 200	125	100		<b>114,85</b>

ASK FOR TECHNICAL INFORMATION / DEMANDEZ INFORMATIONS TECHNIQUES / SOLICITENOS LA FICHA TÉCNICA / SOLICITE A FICHA TÉCNICA PARA MAIS INFORMAÇÕES

**HAMMERFIX ANCHOR SIX WINGS, POLYAMIDE 6.6, HEXAGONAL HEAD**

CHEVILLE SIX AILETTES, POLYAMIDE 6.6, TÊTE HEXAGONAL

TACO DE NYLON 6 ALAS, POLIAMIDA 6.6, CABEZA HEXAGONAL

TAPITS NYLON, POLIAMIDA, LONGAS, POLIDA 6.6, CABEÇA SEXTAVADA

**TN6H**  
**CABEZA HEXAGONAL**

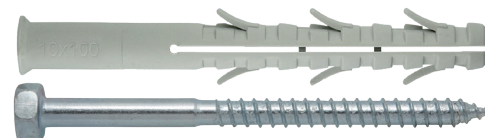
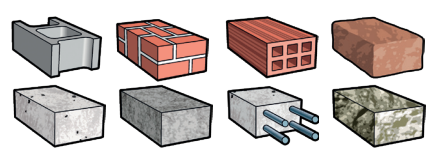

CODE / CÓDIGO	SIZE / MESURE MEDIDA		↓ MAX. ↑			€ / 100
TN6H08080	8 x 80	10	15	100	600	<b>32,26</b>
TN6H08100	8 x 100	10	35	100	400	<b>37,60</b>
TN6H08120	8 x 120	10	55	100	300	<b>41,34</b>
TN6H10100	10 x 100	13	25	100	300	<b>50,51</b>
TN6H10120	10 x 120	13	40	100	300	<b>56,53</b>
TN6H10140	10 x 140	13	60	100	200	<b>64,03</b>
TN6H10160	10 x 160	13	85	100	200	<b>72,65</b>
TN6H10200	10 x 200	13	125	100		<b>122,47</b>

ASK FOR TECHNICAL INFORMATION / DEMANDEZ INFORMATIONS TECHNIQUES / SOLICITENOS LA FICHA TÉCNICA / SOLICITE A FICHA TÉCNICA PARA MAIS INFORMAÇÕES

## EIG PLUS-A

UNIVERSAL FRAME ANCHOR, COUNTERSUNK HEAD, TX

TACO DE NYLON UNIVERSAL, CABEZA AVELLANADA, TX

CHEVILLE UNIVERSELLE NYLON, TÊTE FRAISÉE, TX

BUCHA NYLON UNIVERSAL LONGA COM PARAFUSO, CABEÇA EMBEBER, TX

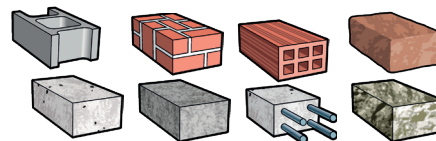
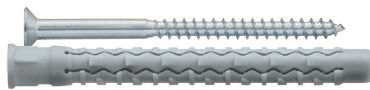

ZINC PLATED / ZINGUÉ / ZINCADO

CODE / CÓDIGO	SIZE / MESURE MEDIDA	★	ETA	Box	€ / 100
TGXA08080	8 x 80	TX30	50	600	30,88
TGXA08100	8 x 100	TX30	50	600	35,42
TGXA08120	8 x 120	TX30	50	300	43,76
TGXA08140	8 x 140	TX30	50	300	55,10
TGXA08170	8 x 170	TX30	50	200	84,53
TGXA08200	8 x 200	TX30	50	150	122,76
TGXA10080	10 x 80	TX40	50	300	55,32

CODE / CÓDIGO	SIZE / MESURE MEDIDA	★	ETA	Box	€ / 100
TGXA10100	10 x 100	TX40	50	300	61,53
TGXA10120	10 x 120	TX40	50	300	64,05
TGXA10140	10 x 140	TX40	50	300	68,97
TGXA10160	10 x 160	TX40	50	200	73,57
TGXA10200	10 x 200	TX40	50	150	117,66
TGXA10240	10 x 240	TX40	50	100	161,66
TGXA10260	10 x 260	TX40	50	100	179,51

## EIG PLUS-H

TACO NYLON UNIVERSAL, CABEZA HEXAGONAL

UNIVERSAL FRAME ANCHOR, HEXAGON WASHER HEAD

CHEVILLE UNIVERSELLE NYLON, TÊTE HEXAGONALE

BUCHA NYLON UNIVERSAL LONGA COM PARAFUSO, CABEÇA SEXTAVADA

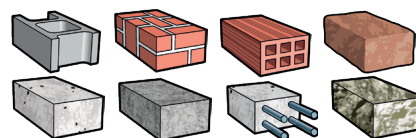
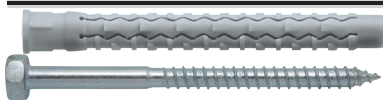

ZINC PLATED / ZINGUÉ / ZINCADO

CODE / CÓDIGO	SIZE / MESURE MEDIDA	★	ETA	Box	€ / 100
TGXH08080	8 x 80	10	50	600	29,75
TGXH08100	8 x 100	10	50	600	33,32
TGXH08120	8 x 120	10	50	300	40,11
TGXH10080	10 x 80	13	50	300	44,73
TGXH10100	10 x 100	13	50	300	51,45

CODE / CÓDIGO	SIZE / MESURE MEDIDA	★	ETA	Box	€ / 100
TGXH10120	10 x 120	13	50	300	61,23
TGXH10140	10 x 140	13	50	200	67,27
TGXH10160	10 x 160	13	50	150	75,39
TGXH10200	10 x 200	13	50	150	120,37
TGXH10240	10 x 240	13	50	100	173,80

## EIG PLUS-AI

UNIVERSAL FRAME ANCHOR, COUNTERSUNK HEAD, **STAINLESS STEEL A4**

CHEVILLE UNIVERSELLE NYLON, TÊTE FRAISÉE TX, **INOXYDABLE A4**

TACO NYLON UNIVERSAL, CABEZA AVELLANADA, TX, **INOX A4**

BUCHA NYLON UNIVERSAL LONGA COM PARAFUSO, CABEÇA EMBEBER, TX, **INOX A4**

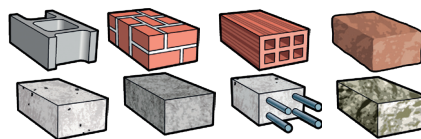
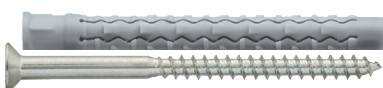

**STAINLESS STEEL A4 / INOXYDABLE A4 / INOXIDABLE A4 / INOX A4**

CODE / CÓDIGO	SIZE / MESURE MEDIDA	★	ETA	Box	€ / 100
TGXAI10080	10 x 80	TX40	50	300	178,59
TGXAI10100	10 x 100	TX40	50	300	153,35
TGXAI10120	10 x 120	TX40	50	300	216,72

CODE / CÓDIGO	SIZE / MESURE MEDIDA	★	ETA	Box	€ / 100
TGXAI10140	10 x 140	TX40	50	300	240,66
TGXAI10160	10 x 160	TX40	50	200	272,05

## EIG PLUS-HI

UNIVERSAL FRAME ANCHOR, HEX WASHER HEAD, **STAINLESS STEEL A4**

CHEVILLE UNIVERSELLE NYLON, TÊTE HEXAGONALE, **INOXYDABLE A4**

TACO NYLON UNIVERSAL, CABEZA HEXAGONAL, **INOX A4**

BUCHA NYLON UNIVERSAL LONGA COM PARAFUSO, CABEÇA SEXTAVADA, **INOX A4**

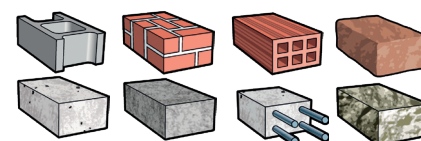
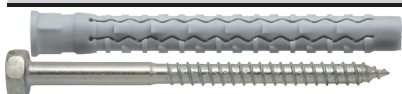

**STAINLESS STEEL A4 / INOXYDABLE A4 / INOXIDABLE A4 / INOX A4**

CODE / CÓDIGO	SIZE / MESURE MEDIDA	★	ETA	Box	€ / 100
TGXHI10080	10 x 80	13	50	300	186,25
TGXHI10100	10 x 100	13	50	300	181,11

CODE / CÓDIGO	SIZE / MESURE MEDIDA	★	ETA	Box	€ / 100
TGXHI10120	10 x 120	13	50	300	253,57

ASK FOR TECHNICAL INFORMATION / DEMANDEZ INFORMATIONS TECHNIQUES / SOLICITENOS LA FICHA TÉCNICA / SOLICITE A FICHA TÉCNICA PARA MAIS INFORMAÇÕES

# NYLON ANCHORS

CHEVILLES NYLON / ANCLAJES NYLON / BUCHAS NYLON

## UNIVERSAL FRAME ANCHOR, COUNTERSUNK HEAD

TACO NYLON UNIVERSAL, CABEZA AVELLANADA  
CHEVILLE UNIVERSELLE NYLON, TÊTE FRAISÉE  
BUCHA NYLON UNIVERSAL, CABEÇA EMBEBER

# TUNA

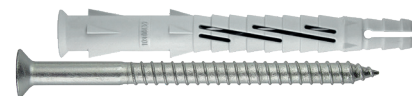
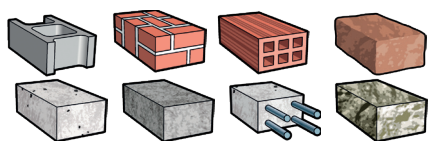

ZINC PLATED / ZINGUÉ / ZINCADO

CODE / CÓDIGO	SIZE / MESURE MEDIDA				€ / 100
TUNA08080	8 x 80	TX30	50	600	<b>39,24</b>
TUNA08100	8 x 100	TX30	50	600	<b>45,04</b>
TUNA08120	8 x 120	TX30	50	300	<b>57,73</b>
TUNA10080	10 x 80	TX40	50	300	<b>51,02</b>
TUNA10100	10 x 100	TX40	50	300	<b>63,07</b>

CODE / CÓDIGO	SIZE / MESURE MEDIDA				€ / 100
TUNA10120	10 x 120	TX40	50	300	<b>75,20</b>
TUNA10140	10 x 140	TX40	50	300	<b>84,84</b>
TUNA10160	10 x 160	TX40	50	200	<b>102,66</b>
TUNA10200	10 x 200	TX40	50	150	<b>134,75</b>
TUNA10230	10 x 230	TX40	50	100	<b>220,30</b>

## UNIVERSAL FRAME ANCHOR, HEXAGON WASHER HEAD

TACO NYLON UNIVERSAL, CABEZA HEXAGONAL  
CHEVILLE UNIVERSELLE NYLON, TÊTE HEXAGONALE  
BUCHA NYLON UNIVERSAL, CABEÇA SEXTAVADO

# TUNH

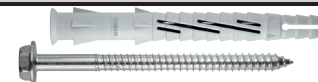
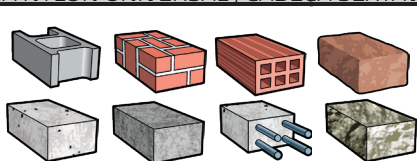

ZINC PLATED / ZINGUÉ / ZINCADO

CODE / CÓDIGO	SIZE / MESURE MEDIDA				€ / 100
TUNH08080	8 x 80	TX30/10	50	600	<b>43,40</b>
TUNH08100	8 x 100	TX30/10	50	600	<b>53,05</b>
TUNH08120	8 x 120	TX30/10	50	300	<b>65,75</b>
TUNH10080	10 x 80	TX40/13	50	300	<b>59,74</b>
TUNH10100	10 x 100	TX40/13	50	300	<b>73,28</b>

CODE / CÓDIGO	SIZE / MESURE MEDIDA				€ / 100
TUNH10120	10 x 120	TX40/13	50	300	<b>80,96</b>
TUNH10140	10 x 140	TX40/13	50	200	<b>102,66</b>
TUNH10160	10 x 160	TX40/13	50	150	<b>122,81</b>
TUNH10200	10 x 200	TX40/13	50	150	<b>152,22</b>
TUNH10230	10 x 230	TX40/13	50	100	<b>243,30</b>

## UNIVERSAL FRAME ANCHOR, COUNTERSUNK HEAD, STAINLESS STEEL A4

CHEVILLE UNIVERSELLE NYLON, TÊTE FRAISÉE, INOXYDABLE A4  
TACO NYLON UNIVERSAL, CABEZA AVELLANADA, INOX A4  
BUCHA NYLON UNIVERSAL, CABEÇA EMBEBER, INOX A4

# TUNAI

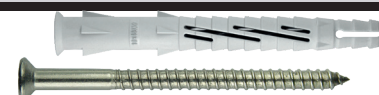
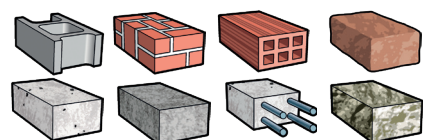

STAINLESS STEEL A4 / INOXYDABLE A4 / INOX A4

CODE / CÓDIGO	SIZE / MESURE MEDIDA				€ / 100
TUNAI08080	8 x 80	TX30	50	600	<b>142,49</b>
TUNAI08100	8 x 100	TX30	50	600	<b>169,86</b>
TUNAI08120	8 x 120	TX30	50	300	<b>198,18</b>
TUNAI10080	10 x 80	TX40	50	300	<b>183,76</b>

CODE / CÓDIGO	SIZE / MESURE MEDIDA				€ / 100
TUNAI10100	10 x 100	TX40	50	300	<b>215,84</b>
TUNAI10120	10 x 120	TX40	50	300	<b>247,65</b>
TUNAI10140	10 x 140	TX40	50	300	<b>314,90</b>
TUNAI10160	10 x 160	TX40	50	200	<b>401,27</b>

## UNIVERSAL FRAME ANCHOR, HEXAGON WASHER HEAD, STAINLESS STEEL A4

CHEVILLE UNIVERSELLE NYLON, TÊTE HEXAGONALE, INOXYDABLE A4  
TACO NYLON UNIVERSAL, CABEZA HEXAGONAL, INOX A4  
BUCHA NYLON UNIVERSAL, CABEÇA SEXTAVADO, INOX A4

# TUNHI

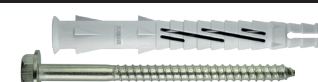
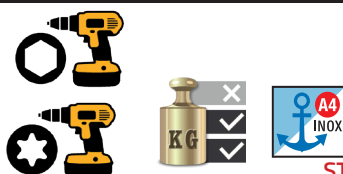
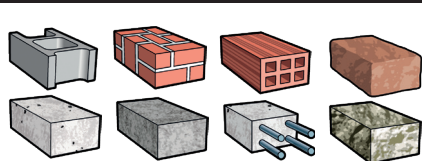

STAINLESS STEEL A4 / INOXYDABLE A4 / INOX A4

CODE / CÓDIGO	SIZE / MESURE MEDIDA				€ / 100
TUNHI08080	8 x 80	TX30/10	50	600	<b>168,10</b>
TUNHI08100	8 x 100	TX30/10	50	600	<b>207,82</b>
TUNHI08120	8 x 120	TX30/10	50	300	<b>251,65</b>
TUNHI10080	10 x 80	TX40/13	50	300	<b>239,36</b>

CODE / CÓDIGO	SIZE / MESURE MEDIDA				€ / 100
TUNHI10100	10 x 100	TX40/13	50	300	<b>269,97</b>
TUNHI10120	10 x 120	TX40/13	50	300	<b>304,79</b>
TUNHI10140	10 x 140	TX40/13	50	200	<b>358,43</b>
TUNHI10160	10 x 160	TX40/13	50	150	<b>426,64</b>

## BR-WHITE

CABLE TIES, POLYAMIDE 6.6, WHITE COLOUR

COLLIER DE SERRAGE, POLYAMIDE 6.6, BLANC COULEUR

BRIDAS DE NYLON, POLIAMIDA 6.6, COLOR NATURAL / BLANCO

ABRACADEIRA DE FIVELA, POLIAMIDA 6.6, BRANCO

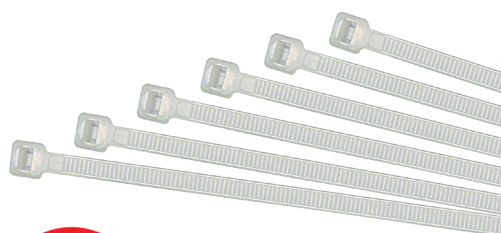

CODE / CÓDIGO	SIZE / MESURE MEDIDA			€ / 100
BRB25080	2,5 x 80	100	1.000	0,63
BRB25100	2,5 x 100	100	1.000	0,68
BRB25140	2,5 x 140	100	1.000	1,04
BRB25160	2,5 x 160	100	1.000	1,16
BRB25200	2,5 x 200	100	1.000	1,51
BRB36140	3,6 x 140	100	1.000	1,44
BRB36200	3,6 x 200	100	1.000	1,97
BRB36300	3,6 x 300	100	1.000	3,20
BRB35370	3,6 x 370	100	1.000	4,33
BRB48120	4,8 x 120	100	1.000	2,25
BRB48160	4,8 x 160	100	1.000	2,42
BRB48180	4,8 x 180	100	1.000	2,46
BRB48200	4,8 x 200	100	1.000	2,51
BRB48250	4,8 x 250	100	1.000	3,80
BRB48290	4,8 x 290	100	1.000	4,10
BRB48370	4,8 x 370	100	1.000	5,16
BRB48430	4,8 x 430	100	1.000	7,58
BRB76150	7,6 x 150	100	500	5,99
BRB76200	7,6 x 200	100	500	6,23
BRB76290	7,6 x 290	100	500	7,87
BRB76370	7,6 x 370	100	500	10,19
BRB76450	7,6 x 450	100	500	15,93
BRB76540	7,6 x 540	100	500	19,71
BRB88770	8,8 x 770	100	500	34,03
BRB12225	12,5 x 225	100	500	22,58
BRB12500	12,5 x 500	100	500	46,94
BRB12720	12,5 x 720	100	500	63,16
BRB12850	12,5 x 850	100	500	77,11
BRB12100	12,5 x 1000	100	500	94,68

BRIDAS DE NYLON, POLIAMIDA 6.6, COLOR NEGRO

CABLE TIES, POLYAMIDE 6.6, BLACK COLOUR

COLLIER DE SERRAGE, POLYAMIDE 6.6, NOIR COULEUR

ABRACADEIRA DE FIVELA, POLIAMIDA 6.6, PRETO

## BR-BLACK



CODE / CÓDIGO	SIZE / MESURE MEDIDA			€ / 100
BRN25080	2,5 x 80	100	1.000	0,63
BRN25100	2,5 x 100	100	1.000	0,68
BRN25140	2,5 x 140	100	1.000	1,04
BRN25160	2,5 x 160	100	1.000	1,16
BRN25200	2,5 x 200	100	1.000	1,51
BRN36140	3,6 x 140	100	1.000	1,44
BRN36200	3,6 x 200	100	1.000	1,97
BRN36300	3,6 x 300	100	1.000	3,20
BRN36370	3,6 x 370	100	1.000	4,33
BRN48120	4,8 x 120	100	1.000	2,25
BRN48160	4,8 x 160	100	1.000	2,42
BRN48180	4,8 x 180	100	1.000	2,46
BRN48200	4,8 x 200	100	1.000	2,51
BRN48250	4,8 x 250	100	1.000	3,80
BRN48290	4,8 x 290	100	1.000	4,10
BRN48370	4,8 x 370	100	1.000	5,16
BRN48430	4,8 x 430	100	1.000	7,58
BRN76150	7,6 x 150	100	500	5,99
BRN76200	7,6 x 200	100	500	6,23
BRN76290	7,6 x 290	100	500	7,87
BRN76370	7,6 x 370	100	500	10,19
BRN76450	7,6 x 450	100	500	15,93
BRN76540	7,6 x 540	100	500	19,71
BRN88770	8,8 x 770	100	500	34,03
BRN12225	12,5 x 225	100	500	22,58
BRN12500	12,5 x 500	100	500	46,94
BRN12720	12,5 x 720	100	500	63,16
BRN12850	12,5 x 850	100	500	77,11
BRN12100	12,5 x 1000	100	500	94,68

# NYLON ANCHORS

CHEVILLES NYLON / ANCLAJES NYLON / BUCHAS NYLON

## CABLE TIES, POLYAMIDE 6.6, GREEN COLOUR

COLLIER DE SERRAGE, POLYAMIDE 6.6, VERT COUL EUR  
BRIDAS DE NYLON, POLIAMIDA 6.6, COLOR VERDE  
ABRACADEIRA DE FIVELA, POLIAMIDA 6.6, VERDE

# BR-GREEN

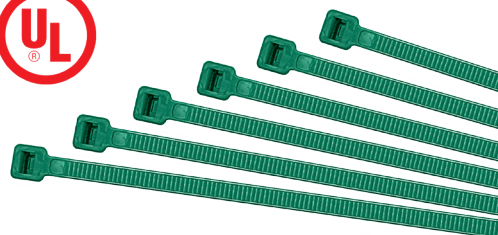

**RAL 6032**

CODE / CÓDIGO	SIZE / MESURE MEDIDA			€ / 100
BRV25100	2,5 x 100	100	1.000	0,91
BRV36140	3,6 x 140	100	1.000	2,34
BRV36200	3,6 x 200	100	1.000	3,01
BRV48200	4,8 x 200	100	1.000	4,09
BRV48290	4,8 x 290	100	1.000	6,12

## CABLE TIES, POLYAMIDE 6.6, BROWN COLOUR

COLLIER DE SERRAGE, POLYAMIDE 6.6, MARRON COULEUR  
BRIDAS DE NYLON, POLIAMIDA 6.6, COLOR MARRÓN  
ABRACADEIRA DE FIVELA, POLIAMIDA 6.6, CASTANHO

# BR-BROWN



**RAL 8011**

CODE / CÓDIGO	SIZE / MESURE MEDIDA			€ / 100
BRM25100	2,5 x 100	100	1.000	0,91
BRM36140	3,6 x 140	100	1.000	2,34
BRM36200	3,6 x 200	100	1.000	3,01
BRM48200	4,8 x 200	100	1.000	4,09
BRM48290	4,8 x 290	100	1.000	6,12

## CABLE TIES, POLYAMIDE 6.6, YELLOW COLOUR

COLLIER DE SERRAGE, POLYAMIDE 6.6, JAUNE COULEUR  
BRIDAS DE NYLON, POLIAMIDA 6.6, COLOR AMARILLO  
ABRACADEIRA DE FIVELA, POLIAMIDA 6.6, AMARELO

# BR-YELLOW



**RAL 1021**

CODE / CÓDIGO	SIZE / MESURE MEDIDA			€ / 100
BRA25100	2,5 x 100	100	1.000	0,91
BRA36140	3,6 x 140	100	1.000	2,34
BRA36200	3,6 x 200	100	1.000	3,01
BRA48200	4,8 x 200	100	1.000	4,09
BRA48290	4,8 x 290	100	1.000	6,12

## CABLE TIES, POLYAMIDE 6.6, BLUE COLOUR

COLLIER DE SERRAGE, POLYAMIDE 6.6, BLEU COULEUR  
BRIDAS DE NYLON, POLIAMIDA 6.6, COLOR AZUL  
ABRACADEIRA DE FIVELA, POLIAMIDA 6.6, AZUL

# BR-BLUE

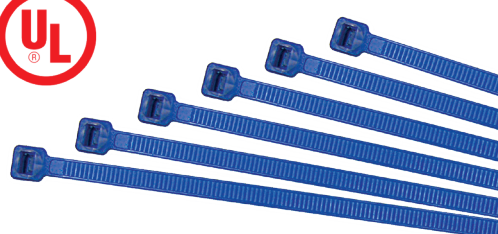

**RAL 5010**

CODE / CÓDIGO	SIZE / MESURE MEDIDA			€ / 100
BRZ25100	2,5 x 100	100	1.000	0,91
BRZ36140	3,6 x 140	100	1.000	2,34
BRZ36200	3,6 x 200	100	1.000	3,01
BRZ48200	4,8 x 200	100	1.000	4,09
BRZ48290	4,8 x 290	100	1.000	6,12

## CABLE TIES, POLYAMIDE 6.6, RED COLOUR

COLLIER DE SERRAGE, POLYAMIDE 6.6, ROUGE COULEUR  
BRIDAS DE NYLON, POLIAMIDA 6.6, COLOR ROJO  
ABRACADEIRA DE FIVELA, POLIAMIDA 6.6, VERMELHO

# BR-RED

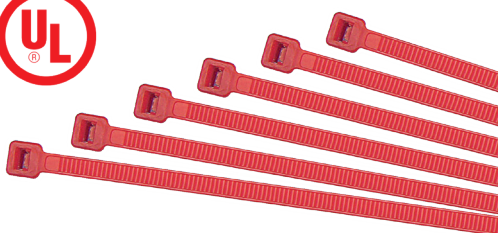



**RAL 3000**

CODE / CÓDIGO	SIZE / MESURE MEDIDA			€ / 100
BRR25100	2,5 x 100	100	1.000	0,91
BRR36140	3,6 x 140	100	1.000	2,34
BRR36200	3,6 x 200	100	1.000	3,01
BRR48200	4,8 x 200	100	1.000	4,09
BRR48290	4,8 x 290	100	1.000	6,12

## BRID

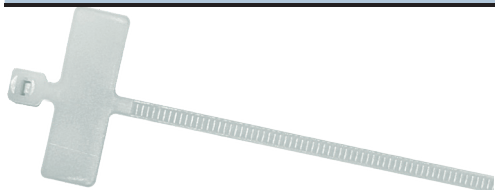
IDENTIFICATION CABLE TIES, POLYAMIDE 6.6, WHITE COLOUR  
COLLIER DE SERRAGE POUR IDENTIFICATION, POLYAMIDE 6.6, BLANC  
BRIDAS DE NYLON PARA IDENTIFICACIÓN, POLIAMIDA 6.6, BLANCA  
ABRACADEIRA DE CABO DE IDENTIFICAÇÃO, POLIAMIDA 6.6, BRANCA





CODE / CÓDIGO	SIZE / MESURE MEDIDA			€ / 100
BRID25100	2,5 x 100	100	1.000	<b>5,98</b>
BRID25200	2,5 x 200	100	1.000	<b>14,00</b>

## BR-PLUG W

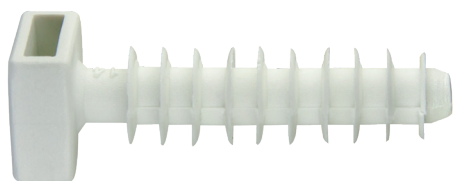
PLUG FOR CABLE TIES SUPPORT, POLYAMIDA 6.6, WHITE COLOUR  
TAQUET COLLIER, POLYAMIDE 6.6, BLANC COULEUR  
TACO PARA BRIDAS NYLON, POLIAMIDA 6.6, COLOR BLANCO  
BUCHA PARA ABRACADEIRA DE FIVELA, POLIAMIDA 6.6, BRANCO





CODE / CÓDIGO	SIZE / MESURE MEDIDA			€ / 100
TABRIBL06	Ø 6	100	5.000	<b>3,67</b>
TABRIBL08	Ø 8	100	1.200	<b>3,67</b>

## BR-PLUG B

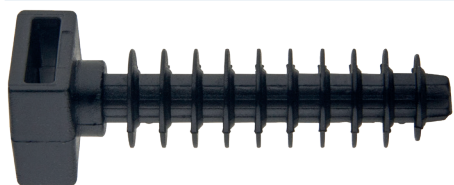
PLUG FOR CABLE TIES SUPPORT, POLYAMIDA 6.6, BLACK COLOUR  
TAQUET COLLIER, POLYAMIDE 6.6, NOIR COULEUR  
TACO PARA BRIDAS NYLON, POLIAMIDA 6.6, COLOR NEGRO  
BUCHA PARA ABRACADEIRA DE FIVELA, POLIAMIDA 6.6, PRETO





CODE / CÓDIGO	SIZE / MESURE MEDIDA			€ / 100
TABRINE06	Ø 6	100	5.000	<b>3,67</b>
TABRINE08	Ø 8	100	1.200	<b>3,67</b>

## BASE W/B

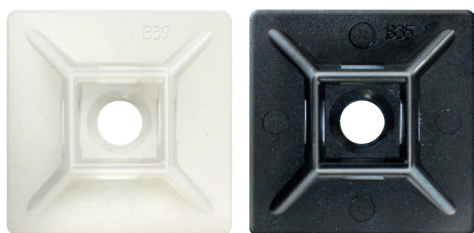

ADHESIVE BASE FOR CABLE TIES, POLYAMIDA 6.6, WHITE/BLACK COLOUR  
BASE ADHESIVE, POUR COLLIERS DE SERRAGE, POLYAMIDE 6.6, BLANC/NOIR  
BASE DOS VIAS ADHESIVA, POLIAMIDA 6.6, COLOR BLANCO/NEGRO  
BASE ADESIVA PARA ABRACADEIRA DE FIVELA, POLIAMIDA 6.6, BRANCO E PRETO



WHITE / BLANC / BLANCA / BRANCO

CODE / CÓDIGO	SIZE / MESURE MEDIDA			€ / 100
BRBABL19	19 x 19	100	10.000	<b>15,33</b>
BRBABL28	28 x 28	100	5.000	<b>21,93</b>

BLACK / NOIR / NEGRA / PRETO

CODE / CÓDIGO	SIZE / MESURE MEDIDA			€ / 100
BRBANE19	19 x 19	100	10.000	<b>15,33</b>
BRBANE28	28 x 28	100	5.000	<b>21,93</b>

## CINPER



ROUNDED PERFORATED BANDING  
BANDE PERFORÉE  
CINTA PERFORADA ONDULADA  
CINTA PERFURADA ONDULADA



GALVANIZED / GALVANISÉE / GALVANIZADA

CODE / CÓDIGO	SIZE / MESURE MEDIDA			€ / 100
CINPEZ1208	12 x 0,8 / 10 m	1	10	<b>4,16</b>
CINPEZ1708	17 x 0,8 / 10 m	1	10	<b>5,28</b>

STAINLESS STEEL / INOXIDABLE / INOX

CODE / CÓDIGO	SIZE / MESURE MEDIDA			€ / 100
CINPEI1708	17 x 0,8 / 10 m	1	10	<b>19,35</b>















# EIG

European Import Group

**4**  
**SCREWS**  
 VIS  
 TORNILLOS  
 PARAFUSOS



**MATERIALS / MATÉRIAUX / MATERIALES / MATERIAIS:**

-   
 PLATE PROFILES  
 PROFILS DE PLAQUE  
 PERFILES DE CHAPA  
 PERFIS DE PLACA
  -   
 SHEET ASSEMBLY  
 ASSEMBLAGE DE LA FEUILLE  
 ENSAMBLAJE DE CHAPAS  
 UNIÃO DE CHAPA
  -   
 ALUMINUM TRIMMER  
 TRIMMER D'ALUMINIUM  
 CARINTERÍA DE ALUMINIO  
 CALHA DE ALUMINIO
  -   
 BEAM PUTRE  
 VIGA  
 VIGA
  -   
 ASBESTOS CEMENT  
 FIBRES-CIMENT  
 FIBROCIMENTO  
 FIBROCIMENTO
  -   
 SANDWICH PANELS  
 PANNEAU SANDWICH  
 PANEL SANDWICH  
 PAINEL SANDWICH
  -   
 WOOD & STEEL  
 BOIS & ACIER  
 MADEIRA & ACERO  
 MADEIRA & FERRO
  -   
 PVC  
 PVC  
 PVC  
 PVC
  -   
 THIN WOOD  
 BOIS MINCE  
 MADEIRA FINA  
 MADEIRA FINA
  -   
 PINE WOOD  
 BOIS PIN  
 MADEIRA PINO  
 MADEIRA PINHO
  -   
 NOBLE WOOD  
 BOIS NOBLE  
 MADEIRA NOBLE  
 MADEIRA NOBRE
-   
 LAMINATED GYPSUM PANEL  
 PANNEAU DE GYPSE LAMINÉ  
 PANEL YESO LAMINADO  
 PLACA DE GESSO

# TBE

## DIN-7504-K

**SELF DRILLING SCREW, HEXAGON WASHER HEAD, ZINC PLATED**  
 VIS AUTOPERCEUSE, POINTE FOREUSE, TÊTE HEXAGONALE A COLLERETTE, ZINGUÉ  
 TORNILLO AUTOTALADRANTE, CABEZA HEXAGONAL, ARANDELA ESTAMPADA, ZINCADO  
 PARAFUSO AUTOPERFORANTE, CABEÇA SEXTAVADA, C/FALSA ANILHA, ZINCADO

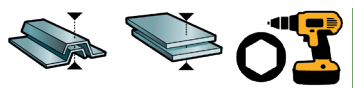
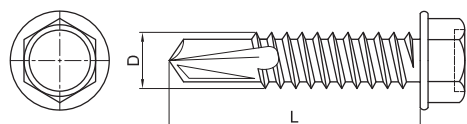
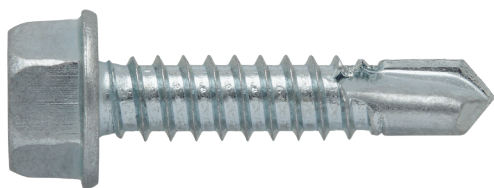
**NUT SELLER / PORTE-EMBOUT / BOCAS**
**P. 76**

AVAILABLE, SEE PAGE:  
 DISPONIBLE, VOIR PAGE:  
 DISPONIBLE, VER PÁGINA:  
 DISPONÍVEL, VER PÁGINA:



AVAILABLE IN RAL COLOURS  
 DISPONIBLE IN RAL COULEURS  
 DISPONIBLE EN COLORES RAL  
 DISPONÍVEL EM CORES RAL



CODE / CÓDIGO	SIZE / ME-SURE / MEDIDA		CAPACITY / CAPACITÉ / CAPACIDAD / CAPACIDADE	MAX			€ / 100
TBEZ3509	3,5 x 9,5	6	2,25 Max.	2,85	1.000	24.000	<b>1,04</b>
TBEZ3513	3,5 x 13	6	2,25 Max.	6,20	1.000	12.000	<b>1,14</b>
TBEZ3516	3,5 x 16	6	2,25 Max.	9,20	1.000	12.000	<b>1,29</b>
TBEZ3519	3,5 x 19	6	2,25 Max.	12,10	1.000	12.000	<b>1,30</b>
TBEZ4213	4,2 x 13	7	3,00 Max.	4,30	1.000	12.000	<b>1,56</b>
TBEZ4216	4,2 x 16	7	3,00 Max.	7,30	1.000	8.000	<b>1,69</b>
TBEZ4219	4,2 x 19	7	3,00 Max.	10,30	1.000	8.000	<b>1,90</b>
TBEZ4225	4,2 x 25	7	3,00 Max.	16,30	500	6.000	<b>2,15</b>
TBEZ4232	4,2 x 32	7	3,00 Max.	23,00	500	6.000	<b>2,38</b>
TBEZ4238	4,2 x 38	7	3,00 Max.	29,00	500	6.000	<b>2,82</b>
TBEZ4813	4,8 x 13	8	4,40 Max.	3,70	1.000	8.000	<b>2,00</b>
TBEZ4816	4,8 x 16	8	4,40 Max.	5,50	1.000	6.000	<b>2,18</b>
TBEZ4819	4,8 x 19	8	4,40 Max.	8,70	500	6.000	<b>2,33</b>
TBEZ4825	4,8 x 25	8	4,40 Max.	14,70	500	6.000	<b>2,63</b>
TBEZ4832	4,8 x 32	8	4,40 Max.	21,50	500	3.000	<b>3,07</b>
TBEZ4838	4,8 x 38	8	4,40 Max.	27,50	500	3.000	<b>3,41</b>
TBEZ4850	4,8 x 50	8	4,40 Max.	39,50	500	2.000	<b>4,17</b>
TBEZ4860	4,8 x 60	8	4,40 Max.	49,50	250	1.000	<b>5,26</b>
TBEZ4870	4,8 x 70	8	4,40 Max.	59,50	250	1.500	<b>5,74</b>
TBEZ5519	5,5 x 19	8	5,25 Max.	8,70	500	6.000	<b>3,05</b>
TBEZ5522	5,5 x 22	8	5,25 Max.	11,70	500	4.000	<b>3,24</b>
TBEZ5525	5,5 x 25	8	5,25 Max.	14,70	500	4.000	<b>3,53</b>
TBEZ5532	5,5 x 32	8	5,25 Max.	21,50	500	3.000	<b>4,10</b>
TBEZ5538	5,5 x 38	8	5,25 Max.	27,50	500	3.000	<b>4,56</b>
TBEZ5550	5,5 x 50	8	5,25 Max.	39,50	500	2.000	<b>5,51</b>
TBEZ5563	5,5 x 63	8	5,25 Max.	52,50	250	1.000	<b>7,04</b>
TBEZ5575	5,5 x 75	8	5,25 Max.	64,50	250	1.500	<b>8,15</b>
TBEZ6319	6,3 x 19	10	6,00 Max.	7,00	500	3.000	<b>4,57</b>
TBEZ6325	6,3 x 25	10	6,00 Max.	13,00	500	3.000	<b>5,06</b>
TBEZ6332	6,3 x 32	10	6,00 Max.	20,00	500	2.000	<b>5,95</b>
TBEZ6338	6,3 x 38	10	6,00 Max.	26,00	500	2.000	<b>6,44</b>
TBEZ6350	6,3 x 50	10	6,00 Max.	38,00	250	1.500	<b>7,84</b>
TBEZ6363	6,3 x 63	10	6,00 Max.	51,00	250	1.500	<b>9,33</b>
TBEZ6375	6,3 x 75	10	6,00 Max.	63,00	250	1.000	<b>11,28</b>
TBEZ6380	6,3 x 80	10	6,00 Max.	68,00	250	1.000	<b>11,82</b>
TBEZ6390	6,3 x 90	10	6,00 Max.	78,00	250	750	<b>14,91</b>
TBEZ6310	6,3 x 100	10	6,00 Max.	88,00	100	600	<b>15,65</b>
TBEZ6311	6,3 x 110	10	6,00 Max.	98,00	100	600	<b>18,78</b>
TBEZ6312	6,3 x 120	10	6,00 Max.	108,00	100	600	<b>21,96</b>
TBEZ6313	6,3 x 130	10	6,00 Max.	118,00	100	600	<b>27,96</b>
TBEZ6314	6,3 x 140	10	6,00 Max.	128,00	100	600	<b>29,68</b>
TBEZ6315	6,3 x 150	10	6,00 Max.	138,00	100	600	<b>31,95</b>
TBEZ6316	6,3 x 160	10	6,00 Max.	148,00	100	400	<b>35,63</b>
TBEZ6318	6,3 x 180	10	6,00 Max.	168,00	100	300	<b>46,87</b>
TBEZ6320	6,3 x 200	10	6,00 Max.	188,00	100	300	<b>51,87</b>
TBEZ6322	6,3 x 220	10	6,00 Max.	208,00	100	300	<b>58,94</b>
TBEZ6324	6,3 x 240	10	6,00 Max.	228,00	100	900	<b>66,68</b>

ASK FOR TECHNICAL INFORMATION / DEMANDEZ INFORMATIONS TECHNIQUES / SOLICITENOS LA FICHA TÉCNICA / SOLICITE A FICHA TÉCNICA PARA MAIS INFORMAÇÕES

# TBE+TARNE

## DIN-7504-K

**SELF DRILLING SCREW, HEXAGON WASHER HEAD, ASSEMBLED**  
 VIS AUTOPERCEUSE, POINTE FOREUSE, TÊTE HEXAGONALE A COLLERETTE, **MONTÉ**  
 TORNILLO AUTOTALADRANTE, CABEZA HEXAGONAL, **MONTADO**  
 PARAFUSO AUTOPERFORANTE, CABEÇA SEXTAVADA, C/FALSA ANILHA, **C/EPDM 16MM**

**Boat of plastic**



CODE / CÓDIGO	SIZE / MESURE / MEDIDA		€ / 1 PC
TBE144819BP	4,8 x 19, Assembled / Monté / Montado	P-14	1.250 <b>78,60</b>
TBE164819BP	4,8 x 19, Assembled / Monté / Montado	P-16	1.250 <b>81,25</b>
TBE165522BP	5,5 x 22, Assembled / Monté / Montado	P-16	1.250 <b>90,55</b>
TBE166325BP	6,3 x 25, Assembled / Monté / Montado	P-16	750 <b>74,20</b>

# SCREWS

VIS / TORNILLOS / PARAFUSOS



## SELF DRILLING SCREW, HEXAGON WASHER HEAD, ASSEMBLED

VIS AUTOPERCEUSE, POINTE FOREUSE, TÊTE HEXAG. A COLLERETTE, MONTÉ

TORNILLO AUTOTALADRANTE, CABEZA HEXAGONAL, MONTADO

PARAFUSO AUTOPERFORANTE, CABEÇA SEXTAVADA, C/FALSA ANILHA, C/EPDM MONTADO

# TBE+TARNE

DIN-7504-K



AVAILABLE IN RAL COLOURS  
DISPONIBLE IN RAL COULEURS  
DISPONIBLE EN  
COULEURS RAL  
DISPONÍVEL EM  
CORES RAL

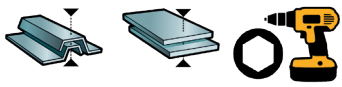

NUT SELLER / PORTE-EMBOUT / BOCAS

P. 76

AVAILABLE, SEE PAGE:  
DISPONIBLE, VOIR PAGE:  
DISPONÍVEL, VER PÁGINA:  
DISPONÍVEL, VER PÁGINA:

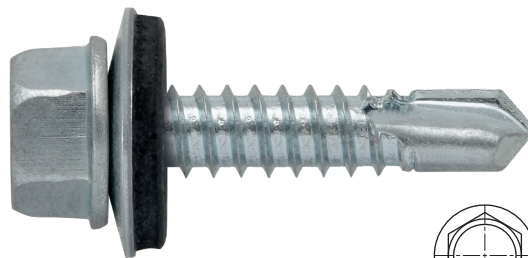

RED SIZES, PLEASE CONSULT DELIVERY TIME | MESURES EN COULEUR ROUGE, DEMANDER DÉLAI | MEDIDAS EN COLOR ROJO,  
CONSULTAR PLAZO | MEDIDAS EM COR VERMELHA, CONSULTAR O PRAZO DE ENTREGA

SIZE / MESURE MEDIDA	Assembled Washer Monté avec Rondelle Montado Arandela Montado C/anihla <b>P-14</b>			Assembled Washer Monté avec Rondelle Montado Arandela Montado C/anihla <b>P-16</b>			Assembled Washer Monté avec Rondelle Montado Arandela Montado C/anihla <b>P-18</b>			Assembled Washer Monté avec Rondelle Montado Arandela Montado C/anihla <b>P-25</b>		
	CODE CÓDIGO	€ / 100		CODE CÓDIGO	€ / 100		CODE CÓDIGO	€ / 100		CODE CÓDIGO	€ / 100	
3,5 x 9,5	TBE143509	1.000	7,56	TBE163509	1.000	7,68	TBE183509	500	8,91	TBE253509	250	12,09
3,5 x 13	TBE143513	1.000	7,70	TBE163513	1.000	7,81	TBE183513	500	9,04	TBE253513	250	12,38
3,5 x 16	TBE143516	1.000	7,78	TBE163516	1.000	7,91	TBE183516	500	9,22	TBE253516	250	12,48
3,5 x 19	TBE143519	1.000	7,97	TBE163519	1.000	8,05	TBE183519	500	9,37	TBE253519	250	12,63
4,2 x 13	TBE144213	1.000	8,40	TBE164213	1.000	8,52	TBE184213	500	9,84	TBE254213	250	13,10
4,2 x 16	TBE144216	1.000	8,66	TBE164216	1.000	8,75	TBE184216	500	10,06	TBE254216	250	13,32
4,2 x 19	TBE144219	1.000	3,63	TBE164219	1.000	3,57	TBE184219	500	10,27	TBE254219	250	13,52
4,2 x 25	TBE144225	1.000	4,81	TBE164225	1.000	6,49	TBE184225	500	10,60	TBE254225	250	13,86
4,2 x 32	TBE144232	1.000	9,64	TBE164232	1.000	9,80	TBE184232	500	11,04	TBE254232	250	14,29
4,2 x 38	TBE144238	1.000	10,15	TBE164238	1.000	10,23	TBE184238	500	11,66	TBE254238	250	14,73
4,8 x 13	TBE144813	1.000	9,12	TBE164813	1.000	9,20	TBE184813	500	10,52	TBE254813	250	13,78
4,8 x 16	TBE144816	1.000	3,58	TBE164816	1.000	4,33	TBE184816	500	10,69	TBE254816	250	13,95
4,8 x 19	TBE144819	1.000	3,82	TBE164819	1.000	4,34	TBE184819	500	4,43	TBE254819	250	14,20
4,8 x 25	TBE144825	1.000	4,20	TBE164825	1.000	4,92	TBE184825	500	5,62	TBE254825	250	14,70
4,8 x 32	TBE144832	1.000	5,03	TBE164832	1.000	5,32	TBE184832	500	12,11	TBE254832	250	15,37
4,8 x 38	TBE144838	1.000	5,34	TBE164838	1.000	5,18	TBE184838	500	6,36	TBE254838	250	15,91
4,8 x 50	TBE144850	500	13,33	TBE164850	500	13,42	TBE184850	500	14,54	TBE254850	250	16,77
4,8 x 60	TBE144860	500	14,82	TBE164860	250	14,90	TBE184860	250	16,02	TBE254860	125	19,03
4,8 x 70	TBE144870	250	16,24	TBE164870	250	16,32	TBE184870	250	17,45	TBE254870	125	20,21
5,5 x 19	TBE145519	1.000	10,62	TBE165519	1.000	4,85	TBE185519	500	12,03	TBE255519	250	15,28
5,5 x 22	TBE145522	1.000	4,76	TBE165522	1.000	5,01	TBE185522	500	6,02	TBE255522	250	7,87
5,5 x 25	TBE145525	1.000	11,44	TBE165525	1.000	5,29	TBE185525	500	6,79	TBE255525	250	9,45
5,5 x 32	TBE145532	1.000	5,91	TBE165532	1.000	6,55	TBE185532	500	7,47	TBE255532	250	16,98
5,5 x 38	TBE145538	1.000	13,27	TBE165538	500	6,20	TBE185538	500	7,53	TBE255538	250	17,70
5,5 x 50	TBE145550	500	15,49	TBE165550	500	7,33	TBE185550	500	7,98	TBE255550	250	20,11
5,5 x 63	TBE145563	500	17,87	TBE165563	250	8,54	TBE185563	250	19,32	TBE255563	125	23,27
5,5 x 75	TBE145575	250	19,72	TBE165575	250	10,57	TBE185575	250	21,52	TBE255575	125	24,87
6,3 x 19	TBE146319	1.000	13,07	TBE166319	1.000	6,79	TBE186319	500	14,55	TBE256319	250	17,65
6,3 x 25	TBE146325	1.000	14,38	TBE166325	500	6,65	TBE186325	500	8,17	TBE256325	250	9,94
6,3 x 32	TBE146332	500	15,52	TBE166332	500	7,61	TBE186332	500	7,91	TBE256332	250	20,14
6,3 x 38	TBE146338	500	16,49	TBE166338	500	7,98	TBE186338	500	9,45	TBE256338	250	21,11
6,3 x 50	TBE146350	500	19,13	TBE166350	250	10,87	TBE186350	250	9,24	TBE256350	125	15,05
6,3 x 63	TBE146363	250	22,13	TBE166363	250	10,94	TBE186363	250	10,99	TBE256363	125	17,01
6,3 x 75	TBE146375	250	24,33	TBE166375	250	14,53	TBE186375	250	12,95	TBE256375	125	29,48
6,3 x 80	TBE146380	250	26,74	TBE166380	100	16,28	TBE186380	100	14,63	TBE256380	100	31,84
6,3 x 90	TBE146390	250	29,47	TBE166390	100	20,86	TBE186390	100	17,92	TBE256390	100	34,58
6,3 x 100	TBE146310	100	32,94	TBE166310	100	19,67	TBE186310	100	19,53	TBE256310	100	37,79
6,3 x 110	TBE146311	100	38,31	TBE166311	100	21,05	TBE186311	100	24,43	TBE256311	100	43,17
6,3 x 120	TBE146312	100	41,95	TBE166312	100	23,20	TBE186312	100	28,60	TBE256312	100	48,29
6,3 x 130	TBE146313	100	53,17	TBE166313	100	34,79	TBE186313	100	39,06	TBE256313	100	59,51
6,3 x 140	TBE146314	100	56,99	TBE166314	100	36,90	TBE186314	100	41,73	TBE256314	100	63,33
6,3 x 150	TBE146315	100	61,94	TBE166315	100	58,15	TBE186315	100	63,15	TBE256315	100	66,02
6,3 x 160	TBE146316	100	68,24	TBE166316	100	64,07	TBE186316	100	69,45	TBE256316	100	72,32
6,3 x 180	TBE146318	100	87,51	TBE166318	100	82,75	TBE186318	100	88,72	TBE256318	100	91,59
6,3 x 200	TBE146320	100	96,05	TBE166320	100	90,38	TBE186320	100	97,26	TBE256320	100	100,13
6,3 x 220	TBE146322	100	108,18	TBE166322	100	101,23	TBE186322	100	109,39	TBE256322	100	112,26
6,3 x 240	TBE146324	100	121,47	TBE166324	100	114,90	TBE186324	100	122,68	TBE256324	100	125,55

ASK FOR TECHNICAL INFORMATION / DEMANDEZ INFORMATIONS TECHNIQUES / SOLICITENOS LA FICHA TÉCNICA / SOLICITE A FICHA TÉCNICA PARA MAIS INFOR-  
MAÇÕES

# TBE-INOX

## DIN-7504-K

SELF DRILLING SCREW, HEXAGON WASHER HEAD, **STAINLESS STEEL A2**  
VIS AUTOPERCEUSE, POINTE FOREUSE, TÊTE HEXAGONALE A COLLERETTE, **INOXYDABLE A2**  
TORNILLO AUTOTALADRANTE, CABEZA HEXAGONAL, ARANDELA ESTAMPADA, **INOX A2**  
PARAFUSO AUTOPERFORANTE, CABEÇA SEXTAVADA, C/FALSA ANILHA, **INOX A2**

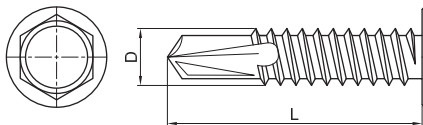
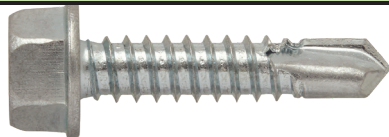

**STAINLESS STEEL A2 / INOXYDABLE A2 / INOXIDABLE A2 / INOX A2** **STAINLESS STEEL A2 / INOXYDABLE A2 / INOXIDABLE A2 / INOX A2**

CODE CÓ-DIGO	SIZE / MESURE MEDIDA				€ / 100
TBEI4213	4,2 x 13	7	500	12.000	<b>7,79</b>
TBEI4216	4,2 x 16	7	500	12.000	<b>8,74</b>
TBEI4219	4,2 x 19	7	500	12.000	<b>9,05</b>
TBEI4813	4,8 x 13	8	250	6.000	<b>11,01</b>
TBEI4816	4,8 x 16	8	250	6.000	<b>11,30</b>
TBEI4819	4,8 x 19	8	250	6.000	<b>11,65</b>
TBEI4825	4,8 x 25	8	250	6.000	<b>13,04</b>
TBEI4832	4,8 x 32	8	250	6.000	<b>15,51</b>
TBEI4838	4,8 x 38	8	250	3.000	<b>17,37</b>

CODE CÓ-DIGO	SIZE / MESURE MEDIDA				€ / 100
TBEI5519	5,5 x 19	8	250	6.000	<b>16,08</b>
TBEI5522	5,5 x 22	8	250	6.000	<b>18,06</b>
TBEI5525	5,5 x 25	8	250	6.000	<b>18,24</b>
TBEI5538	5,5 x 38	8	250	3.000	<b>23,57</b>
TBEI6319	6,3 x 19	10	250	6.000	<b>24,38</b>
TBEI6325	6,3 x 25	10	250	6.000	<b>27,74</b>
TBEI6332	6,3 x 32	10	250	3.000	<b>33,26</b>
TBEI6338	6,3 x 38	10	250	3.000	<b>35,17</b>

# TARNE

**VULCANIZED EPDM BONDED WASHER**  
RONDELLE VULCANISÉE D'ÉTANCHÉITÉ, EPDM  
ARANDELA DE ESTANQUEIDAD VULCANIZADA - EPDM  
ANILHA VULCANIZADA-EPDM

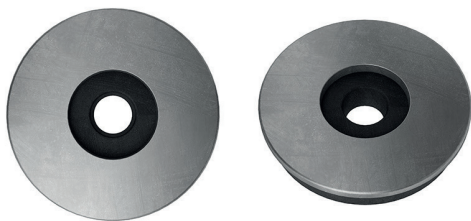

**PREGALVANIZADA / PREGALVANIZED / PREGALVANISÉE**

CODE CÓDIGO	SIZE / ME-SURE MEDIDA	Ø EXT - Ø INT (Ø INT EPDM)			€ / 100
TARNEZ14	Ø 14	Ø 14 - Ø 6,7 (Ø 2,0 EPDM)	1.000	12.000	<b>1,89</b>
TARNEZ16	Ø 16	Ø 16 - Ø 7,0 (Ø 2,5 EPDM)	1.000	6.000	<b>2,07</b>
TARNEZ18	Ø 18	Ø 18 - Ø 7,0 (Ø 3,5 EPDM)	1.000	6.000	<b>2,68</b>
TARNEZ25	Ø 25	Ø 25 - Ø 7,0 (Ø 3,5 EPDM)	500	3.000	<b>4,83</b>

**STAINLESS STEEL A2 / INOXYDABLE A2 / INOXIDABLE A2 / INOX A2**

CODE CÓDIGO	SIZE / ME-SURE MEDIDA	Ø EXT - Ø INT (Ø INT EPDM)			€ / 100
TARNEI14	Ø 14	Ø 14 - Ø 6,7 (Ø 2,0 EPDM)	1.000	12.000	<b>5,38</b>
TARNEI16	Ø 16	Ø 16 - Ø 7,0 (Ø 2,5 EPDM)	1.000	6.000	<b>6,13</b>
TARNEI18	Ø 18	Ø 18 - Ø 7,0 (Ø 3,5 EPDM)	1.000	6.000	<b>7,68</b>
TARNEI25	Ø 25	Ø 25 - Ø 7,0 (Ø 3,5 EPDM)	500	3.000	<b>13,84</b>

# TRE

## DIN-7504-K

SELF DRILLING SCREW, REDUCED DRILL POINT N°1, HEXAGON WASHER HEAD, 8 MM.  
VIS AUTOPERCEUSE, POINTE FOREUSE REDUITE N°1, TÊTE HEXAGONALE, 8 MM.  
TORNILLO AUTOTALADRANTE, PUNTA REDUCIDA N°1, CABEZA HEXAGONAL, 8 MM.  
PARAFUSO AUTOPERFORANTE, BROCA REDUZIDA, CABEÇA SEXTAVADA, 8 MM.

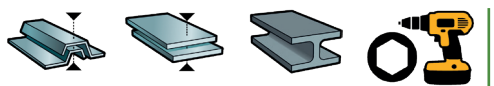
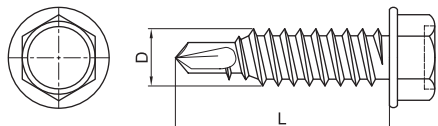
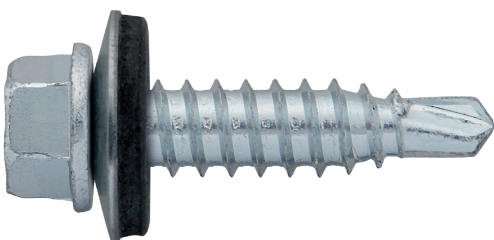

**ZINC PLATED / ZINGUE / ZINCADO**

CODE CÓDIGO	SIZE / ME-SURE MEDIDA		CAPACIDAD CAPACITY / CAPACITÉ	MAX.			€ / 100
TRE4816	4,8 x 16	8	1,00 Max.	8,00	500	6.000	<b>2,46</b>
TRE4819	4,8 x 19	8	1,00 Max.	11,00	500	6.000	<b>2,63</b>
TRE5522	5,5 x 22	8	1,50 Max.	12,00	500	4.000	<b>3,79</b>
TRE6320	6,3 x 20	8	1,50 Max.	9,00	500	3.000	<b>4,20</b>
TRE6325	6,3 x 25	8	1,50 Max.	14,00	500	3.000	<b>4,84</b>
TRE6332	6,3 x 32	8	1,50 Max.	21,00	500	3.000	<b>6,48</b>
TRE6338	6,3 x 38	8	1,50 Max.	27,00	500	3.000	<b>6,92</b>
TRE6350	6,3 x 50	8	1,50 Max.	37,00	250	1.500	<b>8,85</b>
TRE6363	6,3 x 63	8	1,50 Max.	40,00	250	1.500	<b>10,15</b>
TRE6380	6,3 x 80	8	1,50 Max.	57,00	250	1.000	<b>13,93</b>

**ASSEMBLED WASHER P-16 / MONTÉ RONDELLE P-16 / MONTADO ARANDELA P-16 / MONTADO ANILHA P-16**

CODE CÓDIGO	SIZE / MESURE / MEDIDA			€ / 100
TRE164816	<b>4,8 x 16</b> , Assembled / Monté / Montado <b>P-16</b>	500	3.000	<b>5,95</b>
TRE164819	<b>4,8 x 19</b> , Assembled / Monté / Montado <b>P-16</b>	500	3.000	<b>6,38</b>
TRE165522	<b>5,5 x 22</b> , Assembled / Monté / Montado <b>P-16</b>	500	3.000	<b>7,40</b>
TRE166320	<b>6,3 x 20</b> , Assembled / Monté / Montado <b>P-16</b>	500	3.000	<b>7,25</b>
TRE166325	<b>6,3 x 25</b> , Assembled / Monté / Montado <b>P-16</b>	500	3.000	<b>8,26</b>
TRE166332	<b>6,3 x 32</b> , Assembled / Monté / Montado <b>P-16</b>	500	2.000	<b>9,70</b>
TRE166338	<b>6,3 x 38</b> , Assembled / Monté / Montado <b>P-16</b>	500	2.000	<b>11,11</b>
TRE166350	<b>6,3 x 50</b> , Assembled / Monté / Montado <b>P-16</b>	250	1.500	<b>13,09</b>
TRE166363	<b>6,3 x 63</b> , Assembled / Monté / Montado <b>P-16</b>	250	1.500	<b>13,44</b>
TRE166380	<b>6,3 x 80</b> , Assembled / Monté / Montado <b>P-16</b>	250	1.500	<b>18,69</b>

# SCREWS

VIS / TORNILLOS / PARAFUSOS

## TORNILLO AUTOTALADRANTE PARA VIGA, PUNTA BROCA N° 5, CABEZA HEXAGONAL



SELF DRILLING SCREW, DRILL POINT N° 5, HEX WASHER HEAD

VIS AUTOPERCEUSE, POINTE FOREUSE N° 5, TÊTE HEXAGONALE

PARAFUSO AUTOPERFORANTE PARA VIGA, BROCA N°5, CABEÇA SEXTAVADA

# TVI

ZINC PLATED / ZINGUÉ / ZINCADO

CODE CÓDIGO	SIZE / MEASURE / MEDIDA		CAPACIDAD / CAPACITY / CAPACITÉ	↓ MAX. ↑			€ / 100
TVI532	5,5 x 32	8	4,0 - 12,0	12,0 Max.	500	3.000	<b>5,93</b>
TVI538	5,5 x 38	8	4,0 - 12,0	12,0 Max.	500	3.000	<b>6,33</b>

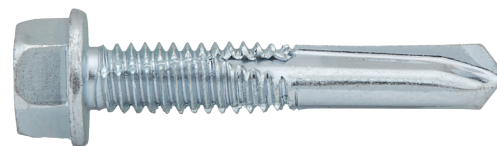

## ASSEMBLED WASHER P-16 / MONTÉ RONDELLE P-16 / MONTADO ARANDELA P-16 / MONTADO C/ ANILHA P-16

CODE CÓDIGO	SIZE / MESURE / MEDIDA			€ / 100
TVI16532	5,5 x 32, Assembled / Monté / Montado P-16	500	2.000	<b>8,01</b>
TVI16538	5,5 x 38, Assembled / Monté / Montado P-16	500	2.000	<b>8,44</b>

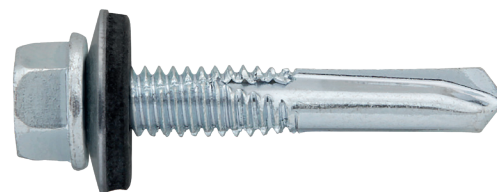

ASK FOR TECHNICAL INFORMATION / DEMANDEZ INFORMATIONS TECHNIQUES / SOLICITENOS LA FICHA TÉCNICA / SOLICITE A FICHA TÉCNICA PARA MAIS INFORMAÇÕES

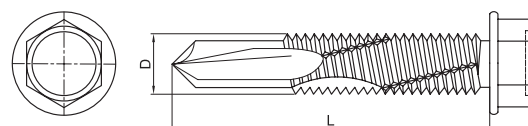
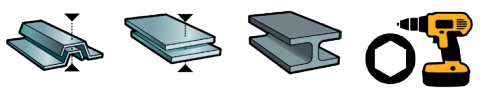

## TORNILLO AUTOTALADRANTE, CABEZA ALOMADA BAJA, ARANDELA ESTAMPADA, PHILLIPS



SELF DRILLING SCREW, EXTRA LOW PAN HEAD WASHER, PHILLIPS RECESS

VIS AUTOPERCEUSE, POINTE FOREUSE, TÊTE CYLINDRIQUE A EMBASE, PHILLIPS

PARAFUSO AUTOPERFORANTE, CABEÇA LARGA, PHILLIPS



# TRB

ZINC PLATED / ZINGUÉ / ZINCADO

CODE CÓDIGO	SIZE / MESURE / MEDIDA		CAPACIDAD / CAPACITY / CAPACITÉ	↓ MAX. ↑			€ / 100
TRBZ4213	4,2 x 13	PH2	0,75 - 2,50	Max. 4,3	500	12.000	<b>2,26</b>
TRBZ4216	4,2 x 16	PH2	0,75 - 2,50	Max. 7,3	500	8.000	<b>2,41</b>
TRBZ4219	4,2 x 19	PH2	0,75 - 2,50	Max. 10,3	500	6.000	<b>2,69</b>
TRBZ4225	4,2 x 25	PH2	0,75 - 2,50	Max. 16,3	500	6.000	<b>2,87</b>
TRBZ4232	4,2 x 32	PH2	0,75 - 2,50	Max. 23,0	500	6.000	<b>3,16</b>



## BLACK ZINC PLATED / ZINGUÉ NOIR / ZINCADO NEGRO / ZINCADO PRETO

CODE CÓDIGO	SIZE / MESURE / MEDIDA		CAPACIDAD / CAPACITY / CAPACITÉ	↓ MAX. ↑			€ / 100
TRBN4213	4,2 x 13	PH2	0,75 - 2,50	Max. 4,3	500	12.000	<b>3,75</b>
TRBN4216	4,2 x 16	PH2	0,75 - 2,50	Max. 7,3	500	8.000	<b>4,27</b>
TRBN4219	4,2 x 19	PH2	0,75 - 2,50	Max. 10,3	500	6.000	<b>4,93</b>
TRBN4225	4,2 x 25	PH2	0,75 - 2,50	Max. 16,3	500	6.000	<b>5,81</b>
TRBN4232	4,2 x 32	PH2	0,75 - 2,50	Max. 23,0	500	6.000	<b>6,73</b>



ASK FOR TECHNICAL INFORMATION / DEMANDEZ INFORMATIONS TECHNIQUES / SOLICITENOS LA FICHA TÉCNICA / SOLICITE A FICHA TÉCNICA PARA MAIS INFORMAÇÕES

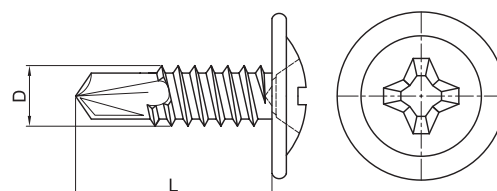
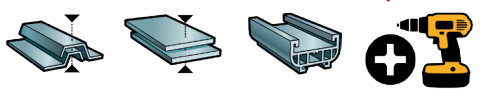

### BITS / EMBOUTS / PUNTAS

P. 76

AVAILABLE, SEE PAGE:  
DISPONIBLE, VER PÁGINA:  
DISPONIBLE, VOIR PAGE:  
DISPONÍVEL, VER PÁGINA:



# TBI

## BIMETAL

SELF DRILLING SCREW, HEX WASHER HEAD, STAINLESS STEEL A2 - BIMETAL  
VIS AUTOPERCEUSE, TÊTE HEXAGONALE A COLLERETTE, INOXYDABLE A2 - BIMETAL  
TORNILLO AUTOTALADRANTE, CABEZA HEXAGONAL, INOXIDABLE A-2 - BIMETAL  
PARAFUSO AUTOPERFORANTE, CABEÇA SEXTAVADA, INOX A2 - BIMETAL

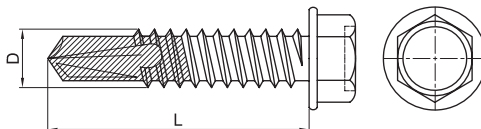

**BIMETAL**

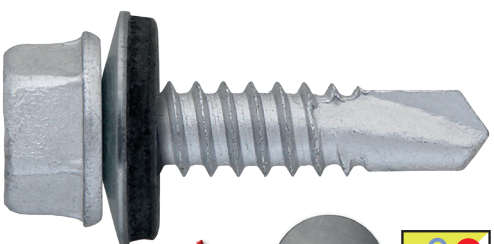

**BIMETAL**

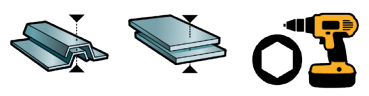
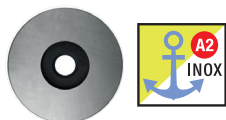

NUT SELLER / PORTE-EMBOUT / BOCAS

P. 76

DISPONIBLE, VER PÁGINA:  
AVAILABLE, SEE PAGE:  
DISPONIBLE, VOIR PAGE:  
DISPONÍVEL, VER PÁGINA:



ACABADO / COATING / TRAITEMENT: **SILVER RUSPERT**

CODE CÓDIGO	SIZE / ME-SURE / MEDIDA	Ø	CAPACIDAD / CAPACITY / CAPACITÉ	↓ MAX. ↑			€ / 100
TBI4825	4,8 x 25	8	4,40 Max.	14,70	500	6.000	42,03
TBI5525	5,5 x 25	8	5,25 Max.	14,70	500	6.000	50,01
TBI5532	5,5 x 32	8	5,25 Max.	21,50	500	3.000	56,77
TBI5538	5,5 x 38	8	5,25 Max.	27,50	500	3.000	60,02
TBI5550	5,5 x 50	8	5,25 Max.	39,50	500	2.000	65,10
TBI5558	5,5 x 58	8	5,25 Max.	47,50	250	1.500	75,63
TBI5565	5,5 x 65	8	5,25 Max.	54,50	250	1.500	79,06
TBI5580	5,5 x 80	8	5,25 Max.	69,50	250	1.000	93,27
TBI6325	6,3 x 25	10	6,00 Max.	13,00	500	3.000	54,14

ASSEMBLED WASHER P-16 / MONTÉ RONDELLE P-16 / MONTADO ARANDELA P-16 / MONTADO ANILHA P-16

CODE CÓDIGO	SIZE / MESURE / MEDIDA			€ / 100
TBI164825	4,8 x 25, Assembled / Monté / Montado P-16	500	2.000	49,63
TBI165525	5,5 x 25, Assembled / Monté / Montado P-16	500	2.000	57,61
TBI165532	5,5 x 32, Assembled / Monté / Montado P-16	500	1.500	64,50
TBI165538	5,5 x 38, Assembled / Monté / Montado P-16	500	1.500	57,79
TBI165550	5,5 x 50, Assembled / Monté / Montado P-16	500	1.500	73,15
TBI165558	5,5 x 58, Assembled / Monté / Montado P-16	250	1.500	83,44
TBI165565	5,5 x 65, Assembled / Monté / Montado P-16	250	1.500	86,83
TBI165580	5,5 x 80, Assembled / Monté / Montado P-16	250	1.000	101,04
TBI166325	6,3 x 25, Assembled / Monté / Montado P-16	500	2.000	58,94

ASK FOR TECHNICAL INFORMATION / DEMANDEZ INFORMATIONS TECHNIQUES / SOLICITENOS LA FICHA TÉCNICA / SOLICITE A FICHA TÉCNICA PARA MAIS INFORMAÇÕES

# TVIB

## BIMETAL

SELF DRILLING SCREW, POINT N° 5, HEX WASHER HEAD, STAINLESS STEEL A2 - BIMETAL  
VIS AUTOPERCEUSE, POINTE FOREUSE N° 5, TÊTE HEXAGONALE, INOXYDABLE A2 - BIMETAL  
TORNILLO VIGA, PUNTA BROCA N° 5, CABEZA HEXAGONAL, INOXIDABLE A2 - BIMETAL  
PARAFUSO PARA VIGAS, BROCA N° 5, CABEÇA SEXTAVADA, INOX A2 - BIMETAL

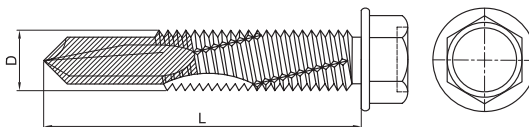

**BIMETAL**

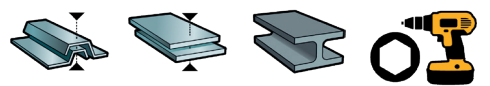

COATING / TRAITEMENT / ACABADO / ACABAMENTO: **SILVER RUSPERT**

CODE CÓDIGO	SIZE / ME-SURE / MEDIDA	Ø	CAPACIDAD / CAPACITY / CAPACITÉ	↓ MAX. ↑			€ / 100
TVIB5540	5,5 x 40	8	4,0 - 12,0	12,0 Max.	500	3.000	64,19
TVIB5550	5,5 x 50	8	4,0 - 12,0	12,0 Max.	500	3.000	92,92
TVIB5565	5,5 x 65	8	4,0 - 12,0	12,0 Max.	250	1.500	97,05
TVIB5580	5,5 x 80	8	4,0 - 12,0	12,0 Max.	250	1.000	119,66
TVIB5510	5,5 x 100	8	4,0 - 12,0	12,0 Max.	100	600	123,37

ASSEMBLED WASHER P-16 / MONTÉ RONDELLE P-16 / MONTADO ARANDELA P-16 / MONTADO C/ ANILHA P-16

CODE CÓDIGO	SIZE / MESURE / MEDIDA			€ / 100
TVIB165540	5,5 x 40, Assembled / Monté / Montado P-16	500	1.500	77,73
TVIB165550	5,5 x 50, Assembled / Monté / Montado P-16	500	1.500	107,13
TVIB165565	5,5 x 65, Assembled / Monté / Montado P-16	250	1.500	110,67
TVIB165580	5,5 x 80, Assembled / Monté / Montado P-16	250	1.000	130,09
TVIB165510	5,5 x 100, Assembled / Monté / Montado P-16	100	600	137,16

ASK FOR TECHNICAL INFORMATION / DEMANDEZ INFORMATIONS TECHNIQUES / SOLICITENOS LA FICHA TÉCNICA / SOLICITE A FICHA TÉCNICA PARA MAIS INFORMAÇÕES

# SCREWS

VIS / TORNILLOS / PARAFUSOS

## SELF DRILLING SCREW FOR FIBRE CEMENT, ASSEMBLED WITH UMBRELLA WASHER

VIS AUTOPERCEUSE, POINTE FOREUSE, POUR FIBRECIMENT, MONTÉE AVEC RONDELLE AMORTISSEUR  
TORNILLO AUTOTALADRANTE PARA FIBROCEMENTO, MONTADO CON ARANDELA PARAGÜAS  
PARAFUSO AUTOPERFORANTE PARA FIBROCIMENTO, C/ANILHA GUARDA-CHUVA

# TFI

### WASHER INOX A2



ZINC PLATED / ZINGUÉ / ZINCADO

CODE CÓDIGO	SIZE / MESURE MEDIDA		BROCA N°	CAPACIDAD CAPACITY / CAPACITÉ	MAX.		€ / 100
TFI63115	6,3 x 115 / # 3	8	3	1,5 - 6,0	85	250	<b>27,30</b>
TFI63125	6,3 x 125 / # 3	8	3	1,5 - 6,0	95	250	<b>44,07</b>
TFI63110	6,3 x 110 / # 5	8	5	6,0 - 12,0	75	250	<b>49,30</b>
TFI63120	6,3 x 120 / # 5	8	5	6,0 - 12,0	85	250	<b>47,67</b>
TFI63130	6,3 x 130 / # 5	8	5	6,0 - 12,0	95	250	<b>52,33</b>
TFI63150	6,3 x 150 / # 5	8	5	6,0 - 12,0	115	250	<b>49,69</b>
TFI63160	6,3 x 160 / # 5	8	5	6,0 - 12,0	125	250	<b>62,81</b>

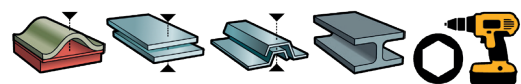
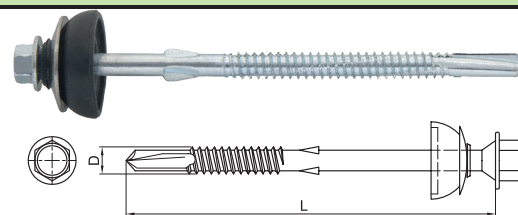

NUT SELLER / PORTE-EMBOUIT / BOCAS

P. 76

DISPONIBLE, VER PÁGINA:  
AVAILABLE, SEE PAGE:  
DISPONIBLE, VOIR PAGE:  
DISPONÍVEL, VER PÁGINA:



ASK FOR TECHNICAL INFORMATION / DEMANDEZ INFORMATIONS TECHNIQUES / SOLICITENOS LA FICHA TÉCNICA / SOLICITE A FICHA TÉCNICA PARA MAIS INFORMAÇÕES

## SELF DRILLING SCREW, WITH TWO THREADS, FOR SANDWICH PANELS, DRILL POINT N° 3

VIS AUTOPERCEUSE, POINTE FOREUSE N° 3, DOUBLE FILET, POUR PANNEAUX SANDWICH  
TORNILLO AUTOTALADRANTE, CON DOS ROSCAS, PARA PANEL SANDWICH, PUNTA BROCA N° 3  
PARAFUSO AUTOPERFORANTE, C/ DUAS ROSCAS, PARA PAINEL SANDWICH, BROCA N° 3

# TS3

ZINC PLATED / ZINGUÉ / ZINCADO

CODE CÓDIGO	SIZE / MESURE MEDIDA		CAPACIDAD CAPACITY / CAPACITÉ	MAX.		€ / 100	
TS355060	5,5 / 6,3 x 60	8	1,5 - 6,0	27 - 44	500	1.500	<b>9,35</b>
TS355082	5,5 / 6,3 x 82	8	1,5 - 6,0	31 - 68	250	1.000	<b>12,70</b>
TS355098	5,5 / 6,3 x 98	8	1,5 - 6,0	48 - 84	250	1.000	<b>15,31</b>
TS355115	5,5 / 6,3 x115	8	1,5 - 6,0	63 -100	250	1.000	<b>18,34</b>

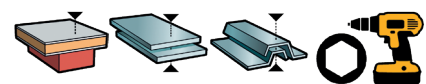
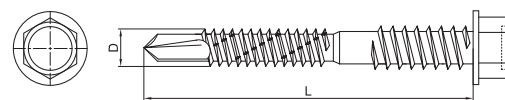

ASSEMBLED WASHER P-16 / MONTÉ RONDELLE P-16 / MONTADO ARANDELA P-16 / MONTADO C/ANILHA P-16

CODE CÓDIGO	SIZE / MESURE / MEDIDA		€ / 100	
TS31655060	5,5 / 6,3 x 60, Assembled/Monté/Montado P-16	250	1.000	<b>12,27</b>
TS31655082	5,5 / 6,3 x 82, Assembled/Monté/Montado P-16	250	1.000	<b>16,24</b>
TS31655098	5,5 / 6,3 x 98, Assembled/Monté/Montado P-16	250	1.000	<b>18,40</b>
TS31655115	5,5 / 6,3 x115, Assembled/Monté/Montado P-16	500		<b>21,27</b>

ASK FOR TECHNICAL INFORMATION / DEMANDEZ INFORMATIONS TECHNIQUES / SOLICITENOS LA FICHA TÉCNICA / SOLICITE A FICHA TÉCNICA PARA MAIS INFORMAÇÕES

## SELF DRILLING SCREW, WITH TWO THREADS, FOR SANDWICH PANELS, DRILL POINT N° 5

VIS AUTOPERCEUSE, POINTE FOREUSE N° 5, DOUBLE FILET, POUR PANNEAUX SANDWICH  
TORNILLO AUTOTALADRANTE, CON DOS ROSCAS, PARA PANEL SANDWICH, PUNTA BROCA N° 5  
PARAFUSO AUTOPERFORANTE, C/ DUAS ROSCAS, PARA PAINEL SANDWICH, BROCA N° 5

# TS5

ZINC PLATED / ZINGUÉ / ZINCADO

CODE CÓDIGO	SIZE / MESURE MEDIDA		CAPACIDAD CAPACITY / CAPACITÉ	MAX.		€ / 100	
TS555075	5,5 / 6,3 x 75	8	4,0 - 12,0	27 - 45	500	1.500	<b>12,91</b>
TS555085	5,5 / 6,3 x 85	8	4,0 - 12,0	31 - 55	250	1.000	<b>15,59</b>
TS555105	5,5 / 6,3 x105	8	4,0 - 12,0	48 - 75	250	1.000	<b>19,98</b>
TS555130	5,5 / 6,3 x130	8	4,0 - 12,0	63 -100	250	750	<b>29,26</b>
TS555150	5,5 / 6,3 x150	8	4,0 - 12,0	63 -120	250	750	<b>33,82</b>

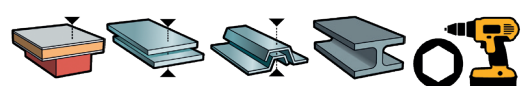
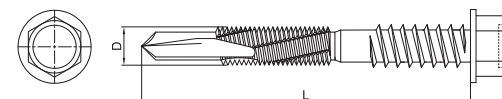
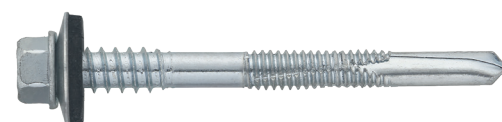

ASSEMBLED WASHER P-16 / MONTÉ RONDELLE P-16 / MONTADO ARANDELA P-16 / MONTADO C/ANILHA P-16

CODE CÓDIGO	SIZE / MESURE / MEDIDA		€ / 100	
TS51655075	5,5 / 6,3 x 75, Assembled/Monté/Montado P-16	250	1.000	<b>16,21</b>
TS51655085	5,5 / 6,3 x 85, Assembled/Monté/Montado P-16	250	1.000	<b>18,78</b>
TS51655105	5,5 / 6,3 x105, Assembled/Monté/Montado P-16	250	1.000	<b>23,85</b>
TS51655130	5,5 / 6,3 x130, Assembled/Monté/Montado P-16	250	1.000	<b>33,03</b>
TS51655150	5,5 / 6,3 x150, Assembled/Monté/Montado P-16	250	1.000	<b>37,30</b>

ASK FOR TECHNICAL INFORMATION / DEMANDEZ INFORMATIONS TECHNIQUES / SOLICITENOS LA FICHA TÉCNICA / SOLICITE A FICHA TÉCNICA PARA MAIS INFORMAÇÕES

# TABA

**SELF DRILLING SCREW, COUNTERSUNK HEAD, WITH TWO WINGS, PHILLIPS**  
 VIS AUTOPERCEUSE, A AILETTES, TÊTE FRAISÉE PHILLIPS. POUR BOIS SUR METAL  
 TORNILLO AUTOTALADRANTE, 2 ALAS, CABEZA AVELLANADA PHILLIPS  
 PARAFUSO AUTOPERFORANTE, C/ 2 ABAS, CABEÇA DE EMBEBER, PHILLIPS



ZINC PLATED / ZINGUÉ / ZINCADO

CODE / CÓDIGO	SIZE / MESURE MEDIDA		CAPACITY CAPACITÉ / CAPACIDAD / CAPACIDADE	MAX.			€ / 100
TABA4832	4,8 x 32	PH2	1,75 - 4,00	14,00	500	6.000	2,78
TABA4838	4,8 x 38	PH2	1,75 - 4,00	20,00	500	6.000	3,14
TABA4845	4,8 x 45	PH2	1,75 - 4,00	27,00	500	3.000	3,80
TABA4850	4,8 x 50	PH2	1,75 - 4,00	32,00	500	3.000	4,22
TABA5538	5,5 x 38	PH2	1,75 - 5,00	17,00	500	3.000	4,80
TABA5545	5,5 x 45	PH2	1,75 - 5,00	24,00	500	3.000	4,89
TABA5555	5,5 x 55	PH2	1,75 - 5,00	34,00	500	3.000	5,84
TABA5565	5,5 x 65	PH2	1,75 - 5,00	44,00	500	2.000	7,09
TABA6360	6,3 x 60	PH2	2,50 - 6,00	38,00	250	1.500	9,26
TABA6370	6,3 x 70	PH2	2,50 - 6,00	48,00	250	1.500	10,54
TABA6385	6,3 x 85	PH2	2,50 - 6,00	61,00	250	1.000	12,65

ASK FOR TECHNICAL INFORMATION / DEMANDEZ INFORMATIONS TECHNIQUES / SOLICITENOS LA FICHA TÉCNICA / SOLICITE A FICHA TÉCNICA PARA MAIS INFORMAÇÕES

# TABA-TX

**SELF DRILLING SCREW, COUNTERSUNK HEAD, WITH TWO WINGS, TX**  
 VIS AUTOPERCEUSE, A AILETTES, TÊTE FRAISÉE TX. POUR BOIS SUR METAL  
 TORNILLO AUTOTALADRANTE, 2 ALAS, CABEZA AVELLANADA TX  
 PARAFUSO AUTOPERFORANTE, C/2ABAS, CABEÇA DE EMBEBER, TX

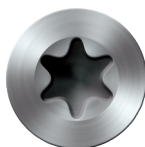

ZINC PLATED / ZINGUÉ / ZINCADO

CODE / CÓDIGO	SIZE / MESURE MEDIDA		CAPACITY CAPACITÉ / CAPACIDAD / CAPACIDADE	MAX.			€ / 100
TABATX4832	4,8 x 32	TX25	1,75 - 4,00	14,00	500	6.000	3,06
TABATX4838	4,8 x 38	TX25	1,75 - 4,00	20,00	500	6.000	3,45
TABATX4845	4,8 x 45	TX25	1,75 - 4,00	27,00	500	3.000	3,98
TABATX4850	4,8 x 50	TX25	1,75 - 4,00	32,00	500	3.000	4,64
TABATX5538	5,5 x 38	TX30	1,75 - 5,00	17,00	500	3.000	5,29
TABATX5545	5,5 x 45	TX30	1,75 - 5,00	24,00	500	3.000	5,38
TABATX5555	5,5 x 55	TX30	1,75 - 5,00	34,00	500	3.000	6,27
TABATX5565	5,5 x 65	TX30	1,75 - 5,00	44,00	500	2.000	7,80
TABATX6360	6,3 x 60	TX30	2,50 - 6,00	38,00	250	1.500	10,19
TABATX6370	6,3 x 70	TX30	2,50 - 6,00	48,00	250	1.500	11,59
TABATX6385	6,3 x 85	TX30	2,50 - 6,00	61,00	250	1.000	13,92

ASK FOR TECHNICAL INFORMATION / DEMANDEZ INFORMATIONS TECHNIQUES / SOLICITENOS LA FICHA TÉCNICA / SOLICITE A FICHA TÉCNICA PARA MAIS INFORMAÇÕES

# SCREWS

VIS / TORNILLOS / PARAFUSOS

## EXTRA LOW HEAD, SELF DRILLING SCREW, PHILLIPS RECESS

VIS AUTOPERCEUSE, POINTE FOREUSE, TÊTE EXTRA PLATE, PHILLIPS

TORNILLO AUTOTALADRANTE, CABEZA EXTRAPLANA, PHILLIPS

PARAFUSO AUTOPERFORANTE, CABEÇA EXTRA PLANA E DE EMBEBER, PHILLIPS

# TBCE

### ZINC PLATED / ZINGUÉ / ZINCADO

CODE CÓDIGO	SIZE / ME-SURE MEDIDA	+	CAPACIDAD CAPACITY / CAPACITÉ	↓ MAX.	TBCE	€ / 100
TBCEZ4214	4,2 x 14	PH2	2,00 Max.	6,00	500	24.000 <b>1,47</b>
TBCEZ4223	4,2 x 23	PH2	2,00 Max.	15,00	500	12.000 <b>2,13</b>

### BLACK ZINC PLATED / ZINGUÉ NOIR / ZINCADO NEGRO / ZINCADO PRETO

CODE CÓDIGO	SIZE / ME-SURE MEDIDA	+	CAPACIDAD CAPACITY / CAPACITÉ	↓ MAX.	TBCE	€ / 100
TBCEN4214	4,2 x 14	PH2	2,00 Max.	6,00	500	24.000 <b>2,18</b>
TBCEN4223	4,2 x 23	PH2	2,00 Max.	15,00	500	12.000 <b>3,19</b>

### WHITE LACQUERED / LAQUÉ BLANC / LACADO BLANCO

CODE CÓDIGO	SIZE / ME-SURE MEDIDA	+	CAPACIDAD CAPACITY / CAPACITÉ	↓ MAX.	TBCE	€ / 100
TBCEB4214	4,2 x 14	PH2	2,00 Max.	6,00	500	24.000 <b>3,40</b>
TBCEB4223	4,2 x 23	PH2	2,00 Max.	15,00	500	12.000 <b>5,11</b>

### LACADA CABEZA BLANCO / WHITE LACQUERED HEAD / TÊTE LAQUÉ BLANC

CODE CÓDIGO	SIZE / ME-SURE MEDIDA	+	CAPACIDAD CAPACITY / CAPACITÉ	↓ MAX.	TBCE	€ / 100
TBCEL4214	4,2 x 14	PH2	2,00 Max.	6,00	500	24.000 <b>6,95</b>
TBCEL4223	4,2 x 23	PH2	2,00 Max.	15,00	500	12.000 <b>8,30</b>

### STAINLESS STEEL A2 / INOXYDABLE A2 / INOXIDABLE A2 / INOX A2

CODE CÓDIGO	SIZE / ME-SURE MEDIDA	+	CAPACIDAD CAPACITY / CAPACITÉ	↓ MAX.	TBCE	€ / 100
TBCEI4214	4,2 x 14	PH2	2,00 Max.	6,00	500	24.000 <b>12,59</b>
TBCEI4223	4,2 x 23	PH2	2,00 Max.	15,00	500	12.000 <b>18,13</b>



ASK FOR TECHNICAL INFORMATION / DEMANDEZ INFORMATIONS TECHNIQUES / SOLICITENOS LA FICHA TÉCNICA / SOLICITE A FICHA TÉCNICA PARA MAIS INFORMAÇÕES



AVAILABLE IN RAL COLOURS  
DISPONIBLE EN RAL COULEURS  
DISPONIBLE EN COLORES RAL  
DISPONÍVEL EM CORES RAL

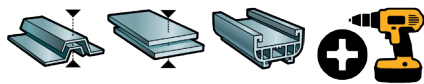

BITS EMBOUTS PUNTAS

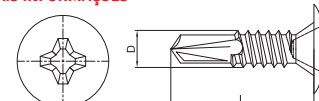

## EXTRA LOW HEAD, SELF TAPPING SCREW, PHILLIPS RECESS

VIS À TÔLE, AVEC TÊTE EXTRA PLATE, PHILLIPS

TORNILLO AUTORROSCANTE, CABEZA EXTRAPLANA, PHILLIPS

PARAFUSO AUTORROSCANTE, CABEÇA EXTRAPLANA E DE EMBEBER, PHILLIPS

# TACE

### ZINC PLATED / ZINGUÉ / ZINCADO

CODE CÓDIGO	SIZE / ME-SURE MEDIDA	+	BROCA Ø	↓ MAX.	TACE	€ / 100
TACEZ4213	4,2 x 13	PH2	3,20 - 3,90	8,00	500	12.000 <b>1,23</b>
TACEZ4222	4,2 x 22	PH2	3,20 - 3,90	17,00	500	12.000 <b>1,69</b>
TACEZ4232	4,2 x 32	PH2	3,20 - 3,90	27,00	500	6.000 <b>2,36</b>

### BLACK ZINC PLATED / ZINGUÉ NOIR / ZINCADO NEGRO / ZINCADO PRETO

CODE CÓDIGO	SIZE / ME-SURE MEDIDA	+	BROCA Ø	↓ MAX.	TACE	€ / 100
TACEN4213	4,2 x 13	PH2	3,20 - 3,90	8,00	500	12.000 <b>1,89</b>
TACEN4222	4,2 x 22	PH2	3,20 - 3,90	17,00	500	12.000 <b>2,73</b>
TACEN4232	4,2 x 32	PH2	3,20 - 3,90	27,00	500	6.000 <b>3,86</b>

### WHITE LACQUERED / LAQUÉ BLANC / LACADO BLANCO

CODE CÓDIGO	SIZE / ME-SURE MEDIDA	+	BROCA Ø	↓ MAX.	TACE	€ / 100
TACEB4213	4,2 x 13	PH2	3,20 - 3,90	8,00	500	12.000 <b>3,40</b>
TACEB4222	4,2 x 22	PH2	3,20 - 3,90	17,00	500	12.000 <b>5,11</b>
TACEB4232	4,2 x 32	PH2	3,20 - 3,90	27,00	500	6.000 <b>6,97</b>

### STAINLESS STEEL A2 / INOXYDABLE A2 / INOXIDABLE A2 / INOX A2

CODE CÓDIGO	SIZE / ME-SURE MEDIDA	+	BROCA Ø	↓ MAX.	TACE	€ / 100
TACEI4213	4,2 x 13	PH2	3,20 - 3,90	8,00	500	12.000 <b>5,21</b>
TACEI4222	4,2 x 22	PH2	3,20 - 3,90	17,00	500	12.000 <b>10,11</b>
TACEI4232	4,2 x 32	PH2	3,20 - 3,90	27,00	500	6.000 <b>12,95</b>



ASK FOR TECHNICAL INFORMATION / DEMANDEZ INFORMATIONS TECHNIQUES / SOLICITENOS LA FICHA TÉCNICA / SOLICITE A FICHA TÉCNICA PARA MAIS INFORMAÇÕES



DISPONIBLE EN COLORES RAL  
AVAILABLE IN RAL COLOURS  
DISPONIBLE EN RAL COULEURS  
DISPONÍVEL EM CORES RAL

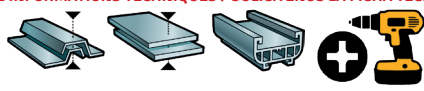

BITS PUNTAS EMBOUTS

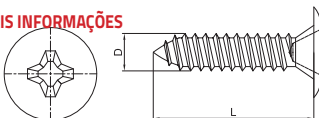

# TBR<sub>DIN-7504-N</sub>

**TORNILLO AUTOTALADRANTE, CABEZA ALOMADA, PHILLIPS**

SELF DRILLING SCREW, PAN HEAD, PHILLIPS RECESS

VIS AUTOPERCEUSE, POINTE FOREUSE, TÊTE CYLINDRIQUE BOMBÉE PHILLIPS

PARAFUSO AUTOPERFORANTE, CABEÇA DE QUEIJO, PHILLIPS

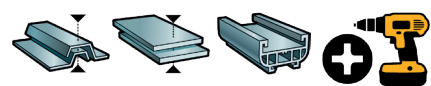
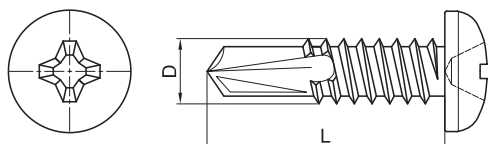
**ZINC PLATED / ZINGUÉ / ZINCADO**

**BITS / EMBOUTS / PUNTAS**

 AVAILABLE, SEE PAGE:  
 DISPONIBLE, VOIR PAGE:  
 DISPONÍVEL, VER PÁGINA:

**P. 76**

 AVAILABLE IN RAL COLOURS  
 DISPONIBLE IN RAL COULEURS  
 DISPONÍVEL EN COLORES RAL  
 DISPONÍVEL EM CORES RAL

CODE CÓ-DIGO	SIZE / ME-SURE MEDIDA	+	CAPACIDAD CAPACITY / CAPACITÉ	MAX.	TBR		€ / 100
TBRZ3509	3,5 x 9,5	PH2	2,25 Max.	3,35	1.000	24.000	<b>0,78</b>
TBRZ3511	3,5 x 11	PH2	2,25 Max.	4,85	1.000	24.000	<b>0,85</b>
TBRZ3513	3,5 x 13	PH2	2,25 Max.	6,85	1.000	24.000	<b>0,91</b>
TBRZ3516	3,5 x 16	PH2	2,25 Max.	9,85	1.000	16.000	<b>1,35</b>
TBRZ3519	3,5 x 19	PH2	2,25 Max.	12,85	1.000	12.000	<b>1,08</b>
TBRZ3522	3,5 x 22	PH2	2,25 Max.	15,85	1.000	12.000	<b>1,22</b>
TBRZ3525	3,5 x 25	PH2	2,25 Max.	18,85	500	12.000	<b>1,36</b>
TBRZ3532	3,5 x 32	PH2	2,25 Max.	25,85	500	6.000	<b>1,61</b>
TBRZ3913	3,9 x 13	PH2	2,40 Max.	6,70	1.000	16.000	<b>1,12</b>
TBRZ3916	3,9 x 16	PH2	2,40 Max.	9,70	1.000	12.000	<b>1,16</b>
TBRZ3919	3,9 x 19	PH2	2,40 Max.	12,70	1.000	12.000	<b>1,28</b>
TBRZ3925	3,9 x 25	PH2	2,40 Max.	18,70	500	8.000	<b>1,59</b>
TBRZ3932	3,9 x 32	PH2	2,40 Max.	25,70	500	6.000	<b>1,92</b>
TBRZ4213	4,2 x 13	PH2	3,00 Max.	5,80	1.000	12.000	<b>1,26</b>
TBRZ4216	4,2 x 16	PH2	3,00 Max.	8,80	1.000	12.000	<b>1,34</b>
TBRZ4219	4,2 x 19	PH2	3,00 Max.	11,80	1.000	12.000	<b>1,51</b>
TBRZ4222	4,2 x 22	PH2	3,00 Max.	14,80	500	8.000	<b>1,61</b>
TBRZ4225	4,2 x 25	PH2	3,00 Max.	17,80	500	6.000	<b>1,79</b>
TBRZ4232	4,2 x 32	PH2	3,00 Max.	24,80	500	6.000	<b>2,10</b>
TBRZ4238	4,2 x 38	PH2	3,00 Max.	30,80	500	6.000	<b>2,35</b>
TBRZ4250	4,2 x 50	PH2	3,00 Max.	42,80	500	3.000	<b>3,00</b>
TBRZ4813	4,8 x 13	PH2	4,40 Max.	5,80	1.000	8.000	<b>1,70</b>
TBRZ4816	4,8 x 16	PH2	4,40 Max.	6,80	1.000	8.000	<b>1,78</b>
TBRZ4819	4,8 x 19	PH2	4,40 Max.	9,80	1.000	8.000	<b>1,96</b>
TBRZ4822	4,8 x 22	PH2	4,40 Max.	12,80	500	6.000	<b>2,31</b>
TBRZ4825	4,8 x 25	PH2	4,40 Max.	15,80	500	6.000	<b>2,35</b>
TBRZ4832	4,8 x 32	PH2	4,40 Max.	22,80	500	6.000	<b>2,74</b>
TBRZ4838	4,8 x 38	PH2	4,40 Max.	28,80	500	3.000	<b>3,11</b>
TBRZ4845	4,8 x 45	PH2	4,40 Max.	35,80	500	3.000	<b>3,61</b>
TBRZ4850	4,8 x 50	PH2	4,40 Max.	40,80	500	3.000	<b>4,14</b>
TBRZ4860	4,8 x 60	PH2	4,40 Max.	50,80	500	2.000	<b>5,53</b>
TBRZ4870	4,8 x 70	PH2	4,40 Max.	60,80	250	1.500	<b>6,26</b>
TBRZ4880	4,8 x 80	PH2	4,40 Max.	70,80	250	1.500	<b>7,23</b>
TBRZ4890	4,8 x 90	PH2	4,40 Max.	80,80	100	1.200	<b>11,27</b>
TBRZ4810	4,8 x 100	PH2	4,40 Max.	90,80	100	1.200	<b>12,59</b>
TBRZ4811	4,8 x 110	PH2	4,40 Max.	100,80	100	1.200	<b>13,65</b>
TBRZ4812	4,8 x 120	PH2	4,40 Max.	110,80	100	1.200	<b>14,03</b>
TBRZ5519	5,5 x 19	PH3	5,25 Max.	8,35	500	6.000	<b>2,78</b>
TBRZ5522	5,5 x 22	PH3	5,25 Max.	11,35	500	6.000	<b>2,98</b>
TBRZ5525	5,5 x 25	PH3	5,25 Max.	14,35	500	4.000	<b>3,04</b>
TBRZ5532	5,5 x 32	PH3	5,25 Max.	21,35	500	3.000	<b>3,69</b>
TBRZ5538	5,5 x 38	PH3	5,25 Max.	27,35	500	3.000	<b>4,15</b>
TBRZ5545	5,5 x 45	PH3	5,25 Max.	34,35	500	3.000	<b>4,66</b>
TBRZ5560	5,5 x 60	PH3	5,25 Max.	49,35	250	1.500	<b>6,52</b>
TBRZ5573	5,5 x 73	PH3	5,25 Max.	62,35	250	1.500	<b>7,86</b>

**BLACK ZINC PLATED / ZINGUÉ NOIR / ZINCADO NEGRO / ZINCADO PRETO**

CODE CÓ-DIGO	SIZE / ME-SURE MEDIDA	+	CAPACIDAD CAPACITY / CAPACITÉ	MAX.	TBR		€ / 100
TBRN3509	3,5 x 9,5	PH2	2,25 Max.	3,35	1.000	24.000	<b>1,23</b>
TBRN3513	3,5 x 13	PH2	2,25 Max.	6,85	1.000	24.000	<b>1,51</b>
TBRN3516	3,5 x 16	PH2	2,25 Max.	9,85	1.000	16.000	<b>1,57</b>
TBRN3519	3,5 x 19	PH2	2,25 Max.	12,85	1.000	12.000	<b>1,72</b>
TBRN4213	4,2 x 13	PH2	3,00 Max.	5,80	1.000	12.000	<b>1,82</b>
TBRN4216	4,2 x 16	PH2	3,00 Max.	8,80	1.000	12.000	<b>2,00</b>
TBRN4219	4,2 x 19	PH2	3,00 Max.	11,80	1.000	12.000	<b>2,26</b>
TBRN4225	4,2 x 25	PH2	3,00 Max.	17,80	500	6.000	<b>2,76</b>
TBRN4232	4,2 x 32	PH2	3,00 Max.	24,80	500	6.000	<b>3,28</b>
TBRN4238	4,2 x 38	PH2	3,00 Max.	30,80	500	6.000	<b>3,85</b>
TBRN4816	4,8 x 16	PH2	4,40 Max.	6,80	1.000	8.000	<b>2,75</b>
TBRN4819	4,8 x 19	PH2	4,40 Max.	9,80	1.000	8.000	<b>3,22</b>
TBRN4825	4,8 x 25	PH2	4,40 Max.	15,80	500	6.000	<b>3,80</b>
TBRN4832	4,8 x 32	PH2	4,40 Max.	22,80	500	6.000	<b>4,57</b>
TBRN4838	4,8 x 38	PH2	4,40 Max.	28,80	500	3.000	<b>4,87</b>
TBRN4845	4,8 x 45	PH2	4,40 Max.	35,80	500	3.000	<b>5,64</b>
TBRN4850	4,8 x 50	PH2	4,40 Max.	40,80	500	3.000	<b>6,12</b>

ASK FOR TECHNICAL INFORMATION / DEMANDEZ INFORMATIONS TECHNIQUES / SOLICITENOS LA FICHA TÉCNICA / SOLICITE A FICHA TÉCNICA PARA MAIS INFORMAÇÕES

# SCREWS

VIS / TORNILLOS / PARAFUSOS

## SELF DRILLING SCREW, PAN HEAD, TX RECESS

VIS AUTOPERCEUSE, POINTE FOREUSE, TÊTE CYLINDRIQUE BOMBÉE TX

TORNILLO AUTOTALADRANTE, CABEZA ALOMADA, TX

PARAFUSO AUTOPERFORANTE, CABEÇA QUEIJO, TX

# TBR-TX

## DIN-7504-N

### ZINC PLATED / ZINGUÉ / ZINCADO

CODE CÓ-DIGO	SIZE / ME-SURE / MEDIDA		CAPACIDAD / CAPACITY / CAPACITÉ	↓ MAX. ↑			€ / 100
TBTZ3509	3,5 x 9,5	TX10	2,25 Max.	3,35	1.000	24.000	1,03
TBTZ3513	3,5 x 13	TX10	2,25 Max.	6,85	1.000	24.000	1,12
TBTZ3516	3,5 x 16	TX10	2,25 Max.	9,85	1.000	16.000	1,21
TBTZ3519	3,5 x 19	TX10	2,25 Max.	12,85	1.000	12.000	1,33
TBTZ4213	4,2 x 13	TX20	3,00 Max.	5,80	1.000	12.000	1,47
TBTZ4216	4,2 x 16	TX20	3,00 Max.	8,80	1.000	12.000	1,59
TBTZ4219	4,2 x 19	TX20	3,00 Max.	11,80	1.000	12.000	1,70
TBTZ4225	4,2 x 25	TX20	3,00 Max.	17,80	500	6.000	2,12
TBTZ4816	4,8 x 16	TX25	4,40 Max.	6,80	1.000	8.000	2,08
TBTZ4819	4,8 x 19	TX25	4,40 Max.	9,80	1.000	8.000	2,21
TBTZ4825	4,8 x 25	TX25	4,40 Max.	15,80	500	6.000	2,68
TBTZ4832	4,8 x 32	TX25	4,40 Max.	22,80	500	6.000	3,10
TBTZ4838	4,8 x 38	TX25	4,40 Max.	28,80	500	3.000	3,53
TBTZ4845	4,8 x 45	TX25	4,40 Max.	35,80	500	3.000	3,93
TBTZ4850	4,8 x 50	TX25	4,40 Max.	40,80	500	3.000	4,23
TBTZ4860	4,8 x 60	TX25	4,40 Max.	50,80	500	2.000	5,11
TBTZ4870	4,8 x 70	TX25	4,40 Max.	60,80	250	1.500	6,06

ASK FOR TECHNICAL INFORMATION / DEMANDEZ INFORMATIONS TECHNIQUES / SOLICITENOS LA FICHA TÉCNICA / SOLICITE A FICHA TÉCNICA PARA MAIS INFORMAÇÕES

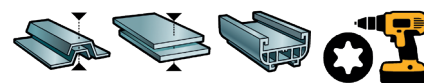
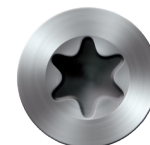
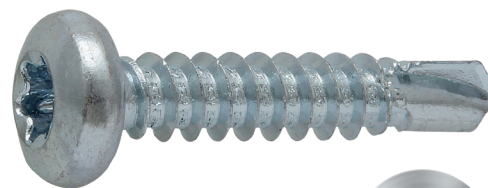

### BITS / EMBOUTS / PUNTAS

P. 76

AVAILABLE, SEE PAGE:  
DISPONIBLE, VOIR PAGE:  
DISPONIBILE, VER PÁGINA:  
DISPONÍVEL, VER PÁGINA:



AVAILABLE IN RAL COLOURS  
DISPONIBLE IN RAL COULEURS  
DISPONIBILE EN COLORES RAL  
DISPONÍVEL EM CORES RAL



### BLACK ZINC PLATED / ZINGUÉ NOIR / ZINCADO NEGRO / ZINCADO PRETO

CODE CÓ-DIGO	SIZE / ME-SURE / MEDIDA		CAPACIDAD / CAPACITY / CAPACITÉ	↓ MAX. ↑			€ / 100
TBTN3509	3,5 x 9,5	TX10	2,25 Max.	3,35	1.000	24.000	1,23
TBTN3513	3,5 x 13	TX10	2,25 Max.	6,85	1.000	24.000	1,37
TBTN3516	3,5 x 16	TX10	2,25 Max.	9,85	1.000	16.000	1,49
TBTN3519	3,5 x 19	TX10	2,25 Max.	12,85	1.000	12.000	1,65
TBTN4213	4,2 x 13	TX20	3,00 Max.	5,80	1.000	12.000	1,82
TBTN4216	4,2 x 16	TX20	3,00 Max.	8,80	1.000	12.000	1,98
TBTN4219	4,2 x 19	TX20	3,00 Max.	11,80	1.000	12.000	2,17
TBTN4225	4,2 x 25	TX20	3,00 Max.	17,80	500	6.000	2,65
TBTN4816	4,8 x 16	TX25	4,40 Max.	6,80	1.000	8.000	2,62
TBTN4819	4,8 x 19	TX25	4,40 Max.	9,80	1.000	8.000	2,85
TBTN4825	4,8 x 25	TX25	4,40 Max.	15,80	500	6.000	3,43
TBTN4832	4,8 x 32	TX25	4,40 Max.	22,80	500	6.000	4,00
TBTN4838	4,8 x 38	TX25	4,40 Max.	28,80	500	3.000	4,55
TBTN4845	4,8 x 45	TX25	4,40 Max.	35,80	500	3.000	5,10
TBTN4850	4,8 x 50	TX25	4,40 Max.	40,80	500	3.000	5,49
TBTN4860	4,8 x 60	TX25	4,40 Max.	50,80	500	2.000	6,49
TBTN4870	4,8 x 70	TX25	4,40 Max.	60,80	250	1.500	7,38

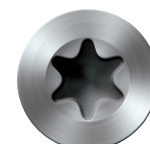
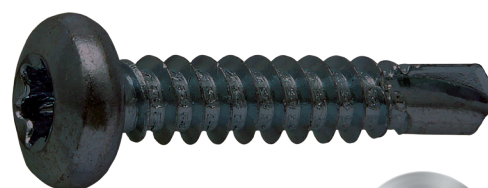

### PVC CAPS FOR HEAD SCREWS DIN-7981 & DIN-7504-N

BOUCHONS EN PVC POUR TÊTE VISES DIN-7981 & DIN-7504-N

TAPONES DE PVC, PARA CABEZAS DE TORNILLOS DIN-7981 & DIN-7504-N

TAMPAS DE PVC, PARA CABEÇAS DE PARAFUSOS DIN-7981 & DIN-7504-N

# TCR

### WHITE - BLANC - BLANCO - BRANCO

CODE CÓDIGO	SIZE / MESURE / MEDIDA			€ / 100
TCR42B	PARA / FOR / POUR Ø 4,2	1.000	12.000	2,45
TCR48B	PARA / FOR / POUR Ø 4,8	1.000	12.000	2,45
TCR55B	PARA / FOR / POUR Ø 5,5	1.000	6.000	2,45

### BLACK - NOIR - NEGRO - PRETO

CODE CÓDIGO	SIZE / MESURE / MEDIDA			€ / 100
TCR42N	PARA / FOR / POUR Ø 4,2	1.000	12.000	2,45
TCR48N	PARA / FOR / POUR Ø 4,8	1.000	12.000	2,45
TCR55N	PARA / FOR / POUR Ø 5,5	1.000	6.000	2,45



# TBR-INOX

DIN-7504-N

SELF DRILLING SCREW, PAN HEAD, PHILLIPS RECESS, **STAINLESS STEEL A2**  
VIS AUTOPERCEUSE, POINTE FOREUSE, TÊTE CYLINDRIQUE BOMBÉE PHILLIPS, **INOXYDABLE A2**  
TORNILLO AUTOTALADRANTE, CABEZA ALOMADA PHILLIPS, **INOX A2**  
PARAFUSO AUTOPERFORANTE, CABEÇA QUEIJO PHILLIPS, **INOX A2**

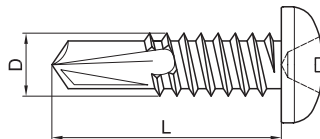
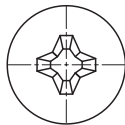

STAINLESS STEEL A2 / INOXYDABLE A2 / INOXIDABLE A2 / INOX A2

STAINLESS STEEL A2 / INOXYDABLE A2 / INOXIDABLE A2 / INOX A2

CODE CÔ-DIGO	SIZE / MESURE MEDIDA	+			€ / 100
TBRI3509	3,5 x 9,5	PH2	500	12.000	<b>5,20</b>
TBRI3513	3,5 x 13	PH2	500	12.000	<b>6,27</b>
TBRI3916	3,9 x 16	PH2	500	12.000	<b>6,53</b>
TBRI3919	3,9 x 19	PH2	500	12.000	<b>6,85</b>
TBRI3925	3,9 x 25	PH2	250	6.000	<b>8,54</b>
TBRI4213	4,2 x 13	PH2	500	12.000	<b>7,37</b>
TBRI4216	4,2 x 16	PH2	500	12.000	<b>8,24</b>
TBRI4219	4,2 x 19	PH2	500	12.000	<b>8,77</b>

CODE CÔ-DIGO	SIZE / MESURE MEDIDA	+			€ / 100
TBRI4225	4,2 x 25	PH2	250	6.000	<b>9,21</b>
TBRI4816	4,8 x 16	PH2	250	6.000	<b>11,54</b>
TBRI4819	4,8 x 19	PH2	250	6.000	<b>11,30</b>
TBRI4825	4,8 x 25	PH2	250	6.000	<b>13,02</b>
TBRI4832	4,8 x 32	PH2	250	6.000	<b>14,70</b>
TBRI4838	4,8 x 38	PH2	250	3.000	<b>16,10</b>
TBRI4850	4,8 x 50	PH2	250	3.000	<b>19,25</b>

# TBR-PINT

DIN-7504-N

SELF DRILLING SCREW, PAN HEAD, PHILLIPS RECESS, **WHITE PAINTED**  
VIS AUTOPERCEUSE, POINTE FOREUSE, TÊTE CYLINDRIQUE BOMBÉE PHILLIPS, **PEINT EN BLANC**  
TORNILLO AUTOTALADRANTE, CABEZA ALOMADA PHILLIPS, **PINTADOS EN BLANCO**  
PARAFUSO AUTOPERFORANTE, CABEÇA DE QUEIJO PHILLIPS, **PINTADOS DE BRANCO**

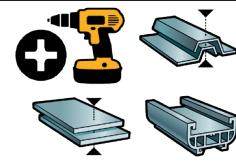
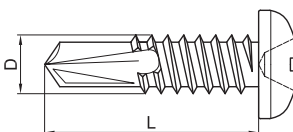
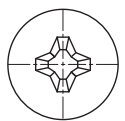

WHITE PAINTED / PEINT EN BLANC / PINTADOS EN BLANCO / PINTADOS DE BRANCO

WHITE PAINTED / PEINT EN BLANC / PINTADOS EN BLANCO / PINTADOS DE BRANCO

CODE CÔ-DIGO	SIZE / MESURE MEDIDA	+			€ / 100
TBRB3509	3,5 x 9,5	PH2	1.000	24.000	<b>1,08</b>
TBRB3513	3,5 x 13	PH2	1.000	24.000	<b>2,91</b>
TBRB3516	3,5 x 16	PH2	1.000	16.000	<b>3,27</b>
TBRB4213	4,2 x 13	PH2	1.000	12.000	<b>3,87</b>

CODE CÔ-DIGO	SIZE / MESURE MEDIDA	+			€ / 100
TBRB4216	4,2 x 16	PH2	1.000	12.000	<b>4,39</b>
TBRB4219	4,2 x 19	PH2	1.000	12.000	<b>4,28</b>
TBRB4825	4,8 x 25	PH2	500	6.000	<b>6,20</b>

**SELF DRILLING SCREW, FLAT HEAD, PHILLIPS RECESS**  
 VIS AUTOPERCEUSE, POINTE FOREUSE, TÊTE FRAISÉE, PHILLIPS  
 TORNILLO AUTOTALADRANTE, CABEZA PLANA, PHILLIPS  
 PARAFUSO AUTOPERFORANTE, CABEÇA DE EMBEBER, PHILLIPS

# TBP

## DIN-7504-P

ZINC PLATED / ZINGUÉ / ZINCADO

CODE CÓ-DIGO	SIZE / MESURE MEDIDA	+	CAPACIDAD CAPACITY / CAPACITÉ	↓ MAX. ↑			€ / 100
TBPZ3509	3,5 x 9,5	PH2	2,25 Max.	2,85	1.000	24.000	<b>0,80</b>
TBPZ3511	3,5 x 11	PH2	2,25 Max.	4,85	1.000	24.000	<b>0,82</b>
TBPZ3513	3,5 x 13	PH2	2,25 Max.	6,85	1.000	24.000	<b>0,87</b>
TBPZ3516	3,5 x 16	PH2	2,25 Max.	9,85	1.000	24.000	<b>0,93</b>
TBPZ3519	3,5 x 19	PH2	2,25 Max.	12,85	1.000	12.000	<b>1,11</b>
TBPZ3522	3,5 x 22	PH2	2,25 Max.	15,85	1.000	12.000	<b>1,26</b>
TBPZ3525	3,5 x 25	PH2	2,25 Max.	18,85	500	12.000	<b>1,29</b>
TBPZ3913	3,9 x 13	PH2	2,40 Max.	6,70	1.000	24.000	<b>1,02</b>
TBPZ3916	3,9 x 16	PH2	2,40 Max.	9,70	1.000	12.000	<b>1,07</b>
TBPZ3919	3,9 x 19	PH2	2,40 Max.	12,70	1.000	12.000	<b>1,22</b>
TBPZ3922	3,9 x 22	PH2	2,40 Max.	15,70	500	12.000	<b>1,37</b>
TBPZ3925	3,9 x 25	PH2	2,40 Max.	18,70	500	12.000	<b>1,58</b>
TBPZ3932	3,9 x 32	PH2	2,40 Max.	25,70	500	6.000	<b>1,67</b>
TBPZ3938	3,9 x 38	PH2	2,40 Max.	31,70	500	6.000	<b>1,94</b>
TBPZ4213	4,2 x 13	PH2	3,00 Max.	5,80	1.000	12.000	<b>1,07</b>
TBPZ4216	4,2 x 16	PH2	3,00 Max.	8,80	1.000	12.000	<b>1,24</b>
TBPZ4219	4,2 x 19	PH2	3,00 Max.	11,80	1.000	12.000	<b>1,41</b>
TBPZ4222	4,2 x 22	PH2	3,00 Max.	14,80	500	12.000	<b>1,47</b>
TBPZ4225	4,2 x 25	PH2	3,00 Max.	17,80	500	6.000	<b>1,65</b>
TBPZ4232	4,2 x 32	PH2	3,00 Max.	24,80	500	6.000	<b>1,93</b>
TBPZ4238	4,2 x 38	PH2	3,00 Max.	30,80	500	6.000	<b>2,32</b>
TBPZ4813	4,8 x 13	PH2	4,40 Max.	3,80	1.000	12.000	<b>1,49</b>
TBPZ4816	4,8 x 16	PH2	4,40 Max.	6,80	1.000	12.000	<b>1,63</b>
TBPZ4819	4,8 x 19	PH2	4,40 Max.	9,80	1.000	8.000	<b>1,76</b>
TBPZ4822	4,8 x 22	PH2	4,40 Max.	12,80	500	6.000	<b>1,91</b>
TBPZ4825	4,8 x 25	PH2	4,40 Max.	15,80	500	6.000	<b>2,05</b>
TBPZ4832	4,8 x 32	PH2	4,40 Max.	22,80	500	6.000	<b>2,61</b>
TBPZ4838	4,8 x 38	PH2	4,40 Max.	28,80	500	3.000	<b>3,04</b>
TBPZ4845	4,8 x 45	PH2	4,40 Max.	35,80	500	3.000	<b>3,26</b>
TBPZ4850	4,8 x 50	PH2	4,40 Max.	40,80	500	3.000	<b>3,82</b>
TBPZ4860	4,8 x 60	PH2	4,40 Max.	50,80	500	2.000	<b>4,57</b>
TBPZ4870	4,8 x 70	PH2	4,40 Max.	60,80	250	1.500	<b>5,64</b>
TBPZ4880	4,8 x 80	PH2	4,40 Max.	70,80	250	1.500	<b>6,61</b>
TBPZ5519	5,5 x 19	PH3	5,25 Max.	8,35	500	6.000	<b>2,49</b>
TBPZ5525	5,5 x 25	PH3	5,25 Max.	14,35	500	6.000	<b>2,82</b>
TBPZ5532	5,5 x 32	PH3	5,25 Max.	21,35	500	3.000	<b>3,52</b>
TBPZ5538	5,5 x 38	PH3	5,25 Max.	27,35	500	3.000	<b>3,98</b>
TBPZ5550	5,5 x 50	PH3	5,25 Max.	39,35	500	3.000	<b>5,11</b>
TBPZ5560	5,5 x 60	PH3	5,25 Max.	49,35	250	1.500	<b>5,78</b>
TBPZ5570	5,5 x 70	PH3	5,25 Max.	59,35	250	1.500	<b>7,02</b>
TBPZ5580	5,5 x 80	PH3	5,25 Max.	69,35	250	1.000	<b>8,51</b>

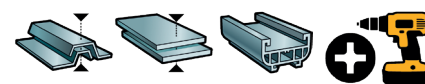
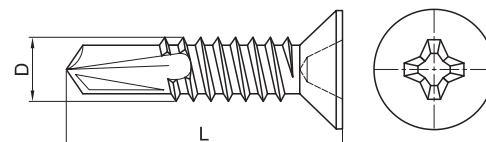

**BITS / EMBOUTS / PUNTAS**

**P. 76**

AVAILABLE, SEE PAGE:  
 DISPONIBLE, VOIR PAGE:  
 DISPONIBLE, VER PÁGINA:  
 DISPONÍVEL, VER PÁGINA



ASK FOR TECHNICAL INFORMATION / DEMANDEZ INFORMATIONS TECHNIQUES / SOLICITENOS LA FICHA TÉCNICA / SOLICITE A FICHA TÉCNICA PARA MAIS INFORMAÇÕES

**BLACK ZINC PLATED / ZINGUÉ NOIR / ZINCADO NEGRO / ZINCADO PRETO**

CODE CÓ-DIGO	SIZE / MESURE MEDIDA	+	CAPACIDAD CAPACITY / CAPACITÉ	↓ MAX. ↑			€ / 100
TBPN3513	3,5 x 13	PH2	2,25 Max.	6,85	1.000	24.000	<b>1,35</b>
TBPN3516	3,5 x 16	PH2	2,25 Max.	9,85	1.000	24.000	<b>1,48</b>
TBPN3519	3,5 x 19	PH2	2,25 Max.	12,85	1.000	12.000	<b>1,66</b>
TBPN3525	3,5 x 25	PH2	2,25 Max.	18,85	500	12.000	<b>2,10</b>
TBPN4216	4,2 x 16	PH2	3,00 Max.	8,80	1.000	12.000	<b>1,82</b>
TBPN4219	4,2 x 19	PH2	3,00 Max.	11,80	1.000	12.000	<b>2,23</b>
TBPN4225	4,2 x 25	PH2	3,00 Max.	17,80	500	6.000	<b>2,66</b>
TBPN4232	4,2 x 32	PH2	3,00 Max.	24,80	500	6.000	<b>3,10</b>
TBPN4238	4,2 x 38	PH2	3,00 Max.	30,80	500	6.000	<b>4,15</b>
TBPN4825	4,8 x 25	PH2	4,40 Max.	15,80	500	6.000	<b>3,68</b>
TBPN4832	4,8 x 32	PH2	4,40 Max.	22,80	500	6.000	<b>4,43</b>
TBPN4838	4,8 x 38	PH2	4,40 Max.	28,80	500	3.000	<b>5,11</b>
TBPN4850	4,8 x 50	PH2	4,40 Max.	40,80	500	3.000	<b>6,02</b>



ASK FOR TECHNICAL INFORMATION / DEMANDEZ INFORMATIONS TECHNIQUES / SOLICITENOS LA FICHA TÉCNICA / SOLICITE A FICHA TÉCNICA PARA MAIS INFORMAÇÕES

# TPVC-10

COUNTERSUNK HEAD SCREW FOR PVC, HI-LO THREAD, HEAD Ø 7,5 MM.  
VIS TÊTE FRAISÉE POUR PVC, FILETAGE HI-LO, TÊTE Ø 7,5 MM.  
TORNILLO CABEZA AVELLANADA PARA PVC, ROSCA HI-LO, CABEZA Ø 7,5 MM.  
PARAFUSO PARA PVC, CABEÇA DE EMBEBER, ROSCA HI-LO, CABEÇA Ø 7,5 MM.

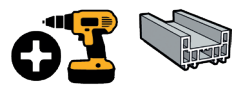

ZINC PLATED / ZINGUÉ / ZINCADO

CÓDIGO CODE	SIZE / MESURE MEDIDA	+			€ / 100
TPV10Z3925	3,9 x 25	PH2	1.000	12.000	1,41
TPV10Z3930	3,9 x 30	PH2	1.000	12.000	1,71
TPV10Z3938	3,9 x 38	PH2	500	6.000	1,96
TPV10Z3945	3,9 x 45	PH2	500	3.000	2,43

# TPVC-20

COUNTERSUNK HEAD SCREW, THREAD 40° FOR PVC, S POINT, REDUCED HEAD Ø 7 MM.  
VIS TÊTE FRAISÉE, FILET 40° POUR PVC, POINTE CLOU, TÊTE Ø 7 MM.  
TORNILLO CABEZA AVELLANADA, FILETE 40° PARA PVC, CABEZA REDUCIDA Ø 7 MM.  
PARAFUSO CABEÇA EMBEBER, ROSCA A 40° PARA PVC, C/ CABEÇA REDUZIDA Ø 7 MM.

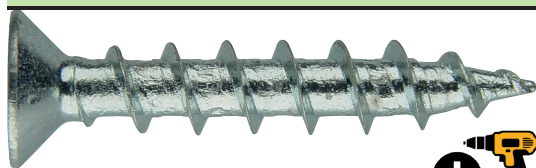

ZINC PLATED / ZINGUÉ / ZINCADO

CODE CÓ-DIGO	SIZE / MESURE MEDIDA	+			€ / 100
TPV20Z4316	4,3 x 16	PH2	1.000	24.000	1,13
TPV20Z4319	4,3 x 19	PH2	1.000	12.000	1,23
TPV20Z4322	4,3 x 22	PH2	1.000	12.000	1,29
TPV20Z4325	4,3 x 25	PH2	1.000	12.000	1,45
TPV20Z4330	4,3 x 30	PH2	1.000	6.000	1,58
TPV20Z4338	4,3 x 38	PH2	500	6.000	2,00
TPV20Z4345	4,3 x 45	PH2	500	3.000	2,59
TPV20Z4355	4,3 x 55	PH2	500	3.000	2,74

YELLOW ZINC / BICHROMATÉ / BICROMATADO / PASS.AMARELO

CODE CÓ-DIGO	SIZE / MESURE MEDIDA	+			€ / 100
TPV20B4316	4,3 x 16	PH2	1.000	24.000	1,13
TPV20B4319	4,3 x 19	PH2	1.000	12.000	1,23
TPV20B4322	4,3 x 22	PH2	1.000	12.000	1,29
TPV20B4325	4,3 x 25	PH2	1.000	12.000	1,45
TPV20B4330	4,3 x 30	PH2	1.000	6.000	1,58
TPV20B4338	4,3 x 38	PH2	500	6.000	2,00
TPV20B4345	4,3 x 45	PH2	500	3.000	2,59
TPV20B4355	4,3 x 55	PH2	500	3.000	2,74

# TPVC-40

SELF DRILLING SCREW FOR PVC, COUNTERSUNK HEAD Ø 7,5 MM.  
VIS TÊTE FRAISÉE POUR PVC, FORET POINTE PILOTE, TÊTE Ø 7,5 MM.  
TORNILLO BROCA CABEZA AVELLANADA PARA PVC, PUNTA PILOTO, Ø CABEZA 7,5 MM.  
PARAFUSO PARA PVC AUTOPERFORANTE CABEÇA DE EMBEBER, C/BROCA GUIA, Ø 7,5 MM.

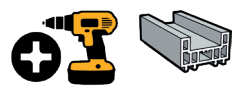

ZINC PLATED / ZINGUÉ / ZINCADO

CODE CÓ-DIGO	SIZE / MESURE MEDIDA	+			€ / 100
TPV40Z3913	3,9 x 13	PH2	1.000	24.000	1,07
TPV40Z3916	3,9 x 16	PH2	1.000	16.000	1,41
TPV40Z3919	3,9 x 19	PH2	1.000	12.000	1,51
TPV40Z3922	3,9 x 22	PH2	1.000	12.000	1,67
TPV40Z3925	3,9 x 25	PH2	1.000	12.000	1,75
TPV40Z3932	3,9 x 32	PH2	1.000	6.000	2,13
TPV40Z3938	3,9 x 38	PH2	500	6.000	2,48

# TPVC-50

SELF DRILLING SCREW FOR PVC, COUNTERSUNK HEAD, METRIC THREAD, HEAD Ø 7,5 MM.  
VIS TÊTE FRAISÉE POUR PVC, FILETAGE MÉTRIQUE, TÊTE Ø 7,5 MM.  
TORNILLO BROCA CABEZA AVELLANADA POR PVC, ROSCA MÉTRICA, Ø CABEZA 7,5 MM.  
PARAFUSO PARA PVC AUTOPERFORANTE, ROSCA MÉTRICA, CABEÇA Ø 7,5 MM.

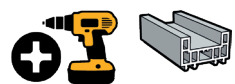
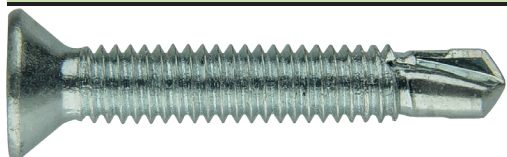

ZINC PLATED / ZINGUÉ / ZINCADO

CODE CÓ-DIGO	SIZE / MESURE MEDIDA	+			€ / 100
TPV50ZM413	M-4 x 13	PH2	1.000	24.000	1,35
TPV50ZM416	M-4 x 16	PH2	1.000	16.000	1,50
TPV50ZM419	M-4 x 19	PH2	1.000	12.000	1,75
TPV50ZM425	M-4 x 25	PH2	1.000	12.000	2,09
TPV50ZM432	M-4 x 32	PH2	1.000	6.000	2,43

# SCREWS

VIS / TORNILLOS / PARAFUSOS

## SELF TAPPING SCREW, HEXAGON WASHER HEAD

VIS AUTOTARAUDEUSE AVEC PRE-PERÇAGE. TÊTE HEXAGONALE À COLLERETTE  
TORNILLO AUTORROSCANTE, CABEZA HEXAGONAL, CON ARANDELA ESTAMPADA  
PARAFUSO AUTORROSCANTE, CABEÇA SEXTAVADA, C/ FALSA ANILHA

# TAU

ZINC PLATED / ZINGUÉ / ZINCADO

CODE CÔ-DIGO	SIZE / ME-SURE MEDIDA		BROCA Ø	MAX.			€ / 100
TAU63019	6,3 x 19	10	5,00 - 5,10	4,00	500	3.000	<b>3,99</b>
TAU63025	6,3 x 25	10	5,00 - 5,10	10,00	500	3.000	<b>4,37</b>
TAU63032	6,3 x 32	10	5,00 - 5,10	17,00	500	2.000	<b>5,07</b>
TAU63040	6,3 x 40	10	5,00 - 5,10	25,00	500	2.000	<b>5,81</b>
TAU63050	6,3 x 50	10	5,00 - 5,10	35,00	500	1.500	<b>6,68</b>
TAU63060	6,3 x 60	10	5,00 - 5,10	45,00	250	1.000	<b>8,15</b>
TAU63080	6,3 x 80	10	5,00 - 5,10	65,00	250	1.000	<b>10,15</b>
TAU63100	6,3 x 100	10	5,00 - 5,10	85,00	250	750	<b>13,65</b>
TAU63110	6,3 x 110	10	5,00 - 5,10	95,00	250	750	<b>15,29</b>
TAU63120	6,3 x 120	10	5,00 - 5,10	105,00	250	750	<b>17,95</b>
TAU63130	6,3 x 130	10	5,00 - 5,10	115,00	250	750	<b>22,05</b>
TAU63140	6,3 x 140	10	5,00 - 5,10	125,00	100	500	<b>25,06</b>
TAU63150	6,3 x 150	10	5,00 - 5,10	135,00	100	400	<b>31,71</b>

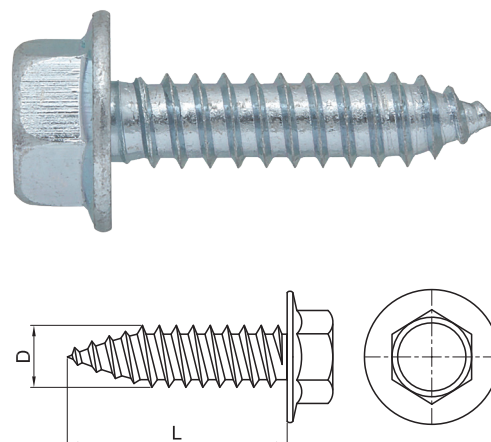

ASK FOR TECHNICAL INFORMATION / DEMANDEZ INFORMATIONS TECHNIQUES / SOLICITENOS LA FICHA TÉCNICA / SOLICITE A FICHA TÉCNICA PARA MAIS INFORMAÇÕES



AVAILABLE IN RAL COLOURS  
DISPONIBLE EN RAL COULEURS  
DISPONIBLE EN COLORES RAL  
DISPONÍVEL EM CORES RAL

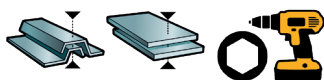

NUT SELLER / PORTE-EMBOUT / BOCAS

P. 76

AVAILABLE, SEE PAGE:

DISPONIBLE, VOIR PAGE:

DISPONIBLE, VER PÁGINA:

DISPONÍVEL, VER PÁGINA:



## SELF TAPPING SCREW, HEXAGON WASHER HEAD, ASSEMBLED

VIS AUTOTARAUDEUSE AVEC PRE-PERÇAGE. TÊTE HEXAGONALE MONTÉ  
TORNILLO AUTORROSCANTE, CABEZA HEXAGONAL, MONTADO  
PARAFUSO AUTORROSCANTE, CABEÇA SEXTAVADA, C/ FALSA ANILHA, MONTADO C/EPDM

# TAU+TARNE



AVAILABLE IN RAL COLOURS  
DISPONIBLE EN RAL COULEURS  
DISPONIBLE EN COLORES RAL  
DISPONÍVEL EM CORES RAL

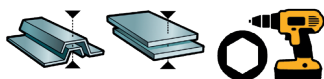

NUT SELLER / PORTE-EMBOUT / BOCAS

P. 76

AVAILABLE, SEE PAGE:

DISPONIBLE, VOIR PAGE:

DISPONIBLE, VER PÁGINA:

DISPONÍVEL, VER PÁGINA:

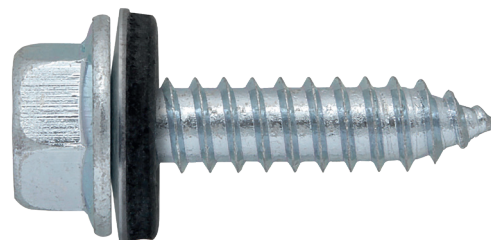

RED SIZES, PLEASE CONSULT DELIVERY TIME | MESURES EN COULEUR ROUGE, DEMANDER DÉLAI | MEDIDAS EN COLOR ROJO, CONSULTAR PLAZO | MEDIDAS EM COR VERMELHA, CONSULTAR O PRAZO DE ENTREGA

MEDIDA SIZE/ME-SURE	Assembled Washer Monté avec Rondelle Montado Arandela Montado C/aniha <b>P-14</b>			Assembled Washer Monté avec Rondelle Montado Arandela Montado C/aniha <b>P-16</b>			Assembled Washer Monté avec Rondelle Montado Arandela Montado C/aniha <b>P-18</b>			Assembled Washer Monté avec Rondelle Montado Arandela Montado C/aniha <b>P-25</b>		
	CODE CÓDIGO		€ / 100	CODE CÓDIGO		€ / 100	CODE CÓDIGO		€ / 100	CODE CÓDIGO		€ / 100
6,3 x 19	TAU1463019	500	<b>13,73</b>	TAU1663019	500	<b>7,27</b>	TAU1863019	500	<b>14,97</b>	TAU2563019	500	<b>19,49</b>
6,3 x 25	TAU1463025	500	<b>14,31</b>	TAU1663025	500	<b>7,57</b>	TAU1863025	500	<b>8,36</b>	TAU2563025	500	<b>13,44</b>
6,3 x 32	TAU1463032	500	<b>16,41</b>	TAU1663032	500	<b>8,75</b>	TAU1863032	500	<b>20,72</b>	TAU2563032	250	<b>22,75</b>
6,3 x 40	TAU1463040	500	<b>17,29</b>	TAU1663040	500	<b>9,53</b>	TAU1863040	500	<b>11,61</b>	TAU2563040	250	<b>23,71</b>
6,3 x 50	TAU1463050	250	<b>19,50</b>	TAU1663050	250	<b>10,71</b>	TAU1863050	250	<b>20,60</b>	TAU2563050	250	<b>25,34</b>
6,3 x 60	TAU1463060	250	<b>21,10</b>	TAU1663060	250	<b>11,73</b>	TAU1863060	250	<b>22,20</b>	TAU2563060	250	<b>27,68</b>
6,3 x 80	TAU1463080	250	<b>27,80</b>	TAU1663080	250	<b>16,17</b>	TAU1863080	250	<b>28,90</b>	TAU2563080	125	<b>34,88</b>
6,3 x 100	TAU1463100	250	<b>33,69</b>	TAU1663100	250	<b>30,69</b>	TAU1863100	250	<b>34,78</b>	TAU2563100	100	<b>43,33</b>
6,3 x 110	TAU1463110	250	<b>36,35</b>	TAU1663110	250	<b>33,11</b>	TAU1863110	250	<b>37,45</b>	TAU2563110	100	<b>46,24</b>
6,3 x 120	TAU1463120	125	<b>38,74</b>	TAU1663120	125	<b>35,28</b>	TAU1863120	125	<b>39,84</b>	TAU2563120	100	<b>48,36</b>
6,3 x 130	TAU1463130	125	<b>45,91</b>	TAU1663130	125	<b>41,80</b>	TAU1863130	125	<b>47,01</b>	TAU2563130	100	<b>56,18</b>
6,3 x 140	TAU1463140	125	<b>58,20</b>	TAU1663140	125	<b>52,97</b>	TAU1863140	125	<b>59,30</b>	TAU2563140	100	<b>69,59</b>
6,3 x 150	TAU1463150	125	<b>62,97</b>	TAU1663150	125	<b>57,31</b>	TAU1863150	125	<b>64,07</b>	TAU2563150	100	<b>74,79</b>

# DIN-7981

SELF TAPPING SCREWS, PAN HEAD, PHILLIPS  
VIS À TOLE, TÊTE CYLINDRIQUE BOMBÉE, PHILLIPS  
TORNILLOS ROSCA CHAPA, CABEZA ALOMADA, PHILLIPS  
PARAFUSO ROSCA CHAPA, CABEÇA QUEIJO, PHILLIPS

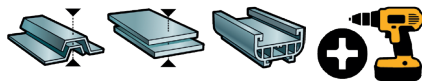
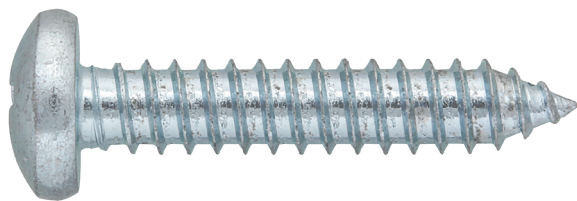

NUT SELLER / PORTE-EMBOUT / BOCAS

P. 76

AVAILABLE, SEE PAGE:  
DISPONIBLE, VOIR PAGE:  
DISPONIBLE, VER PÁGINA:  
DISPONÍVEL, VER PÁGINA:



AVAILABLE IN RAL COLOURS

DISPONIBLE IN  
RAL COULEURS  
DISPONIBLE EN  
COLORES RAL  
DISPONÍVEL EM  
CORES RAL

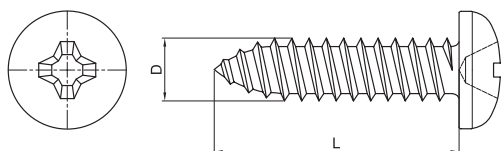

## ZINC PLATED / ZINGUÉ / ZINCADO

CODE CÓ-DIGO	SIZE / MESURE MEDIDA	+			€ / 100
TR81Z29006	2,9 x 6,5	PH1	1.000	48.000	<b>0,53</b>
TR81Z29009	2,9 x 9,5	PH1	1.000	32.000	<b>0,56</b>
TR81Z29013	2,9 x 13	PH1	1.000	24.000	<b>0,65</b>
TR81Z29016	2,9 x 16	PH1	1.000	24.000	<b>0,76</b>
TR81Z29019	2,9 x 19	PH1	1.000	24.000	<b>0,84</b>
TR81Z29022	2,9 x 22	PH1	1.000	12.000	<b>0,87</b>
TR81Z29025	2,9 x 25	PH1	500	12.000	<b>0,98</b>

TR81Z35006	3,5 x 6,5	PH2	1.000	24.000	<b>0,69</b>
TR81Z35009	3,5 x 9,5	PH2	1.000	24.000	<b>0,68</b>
TR81Z35013	3,5 x 13	PH2	500	15.000	<b>0,85</b>
TR81Z35016	3,5 x 16	PH2	500	12.000	<b>0,94</b>
TR81Z35019	3,5 x 19	PH2	500	12.000	<b>1,10</b>
TR81Z35025	3,5 x 25	PH2	250	6.000	<b>1,39</b>
TR81Z35032	3,5 x 32	PH2	250	6.000	<b>1,67</b>

TR81Z39009	3,9 x 9,5	PH2	500	16.000	<b>0,86</b>
TR81Z39013	3,9 x 13	PH2	500	12.000	<b>1,04</b>
TR81Z39016	3,9 x 16	PH2	500	12.000	<b>1,13</b>
TR81Z39019	3,9 x 19	PH2	500	12.000	<b>1,25</b>
TR81Z39022	3,9 x 22	PH2	250	6.000	<b>1,39</b>
TR81Z39025	3,9 x 25	PH2	250	6.000	<b>1,57</b>
TR81Z39032	3,9 x 32	PH2	250	6.000	<b>1,78</b>
TR81Z39038	3,9 x 38	PH2	250	6.000	<b>2,03</b>
TR81Z39045	3,9 x 45	PH2	250	3.000	<b>2,52</b>
TR81Z39050	3,9 x 50	PH2	250	3.000	<b>2,80</b>

TR81Z42009	4,2 x 9,5	PH2	500	12.000	<b>1,07</b>
TR81Z42013	4,2 x 13	PH2	500	12.000	<b>1,19</b>
TR81Z42016	4,2 x 16	PH2	500	12.000	<b>1,30</b>
TR81Z42019	4,2 x 19	PH2	500	8.000	<b>1,35</b>
TR81Z42022	4,2 x 22	PH2	250	6.000	<b>1,68</b>
TR81Z42025	4,2 x 25	PH2	250	6.000	<b>1,76</b>
TR81Z42032	4,2 x 32	PH2	250	6.000	<b>2,11</b>
TR81Z42038	4,2 x 38	PH2	250	3.000	<b>2,31</b>
TR81Z42045	4,2 x 45	PH2	250	3.000	<b>2,60</b>
TR81Z42050	4,2 x 50	PH2	250	3.000	<b>2,71</b>
TR81Z42060	4,2 x 60	PH2	250	3.000	<b>3,92</b>
TR81Z42070	4,2 x 70	PH2	250	1.500	<b>4,39</b>
TR81Z42080	4,2 x 80	PH2	250	1.500	<b>5,23</b>
TR81Z42090	4,2 x 90	PH2	250	1.500	<b>6,41</b>

TR81Z48009	4,8 x 9,5	PH2	500	12.000	<b>1,54</b>
TR81Z48013	4,8 x 13	PH2	500	8.000	<b>1,50</b>
TR81Z48016	4,8 x 16	PH2	250	6.000	<b>1,77</b>
TR81Z48019	4,8 x 19	PH2	250	6.000	<b>2,08</b>
TR81Z48022	4,8 x 22	PH2	250	6.000	<b>2,19</b>

## ZINC PLATED / ZINGUÉ / ZINCADO

CODE CÓ-DIGO	SIZE / MESURE MEDIDA	+			€ / 100
TR81Z48025	4,8 x 25	PH2	250	6.000	<b>2,39</b>
TR81Z48032	4,8 x 32	PH2	250	4.000	<b>2,59</b>
TR81Z48038	4,8 x 38	PH2	250	3.000	<b>3,15</b>
TR81Z48045	4,8 x 45	PH2	250	3.000	<b>3,67</b>
TR81Z48050	4,8 x 50	PH2	250	3.000	<b>4,06</b>
TR81Z48060	4,8 x 60	PH2	250	1.500	<b>5,15</b>
TR81Z48070	4,8 x 70	PH2	100	1.200	<b>5,81</b>
TR81Z48080	4,8 x 80	PH2	100	1.200	<b>7,13</b>
TR81Z48090	4,8 x 90	PH2	100	1.200	<b>8,26</b>
TR81Z48100	4,8 x 100	PH2	100	1.200	<b>8,98</b>
TR81Z48110	4,8 x 110	PH2	100	1.200	<b>10,95</b>
TR81Z48120	4,8 x 120	PH2	100	1.200	<b>12,93</b>

TR81Z55013	5,5 x 13	PH3	250	6.000	<b>2,22</b>
TR81Z55016	5,5 x 16	PH3	250	6.000	<b>2,31</b>
TR81Z55019	5,5 x 19	PH3	250	6.000	<b>2,49</b>
TR81Z55022	5,5 x 22	PH3	250	4.000	<b>2,98</b>
TR81Z55025	5,5 x 25	PH3	250	4.000	<b>3,22</b>
TR81Z55032	5,5 x 32	PH3	250	3.000	<b>3,52</b>
TR81Z55038	5,5 x 38	PH3	250	3.000	<b>4,01</b>
TR81Z55045	5,5 x 45	PH3	250	3.000	<b>4,59</b>
TR81Z55050	5,5 x 50	PH3	250	1.500	<b>5,02</b>
TR81Z55060	5,5 x 60	PH3	100	1.200	<b>6,16</b>
TR81Z55070	5,5 x 70	PH3	100	1.200	<b>6,93</b>
TR81Z55080	5,5 x 80	PH3	100	1.200	<b>8,39</b>
TR81Z55090	5,5 x 90	PH3	100	1.200	<b>9,63</b>
TR81Z55100	5,5 x 100	PH3	100	1.200	<b>11,81</b>
TR81Z55110	5,5 x 110	PH3	100	1.200	<b>14,03</b>
TR81Z55120	5,5 x 120	PH3	100	1.200	<b>15,09</b>

TR81Z63016	6,3 x 16	PH3	250	4.000	<b>3,25</b>
TR81Z63019	6,3 x 19	PH3	250	3.000	<b>3,57</b>
TR81Z63022	6,3 x 22	PH3	250	3.000	<b>3,80</b>
TR81Z63025	6,3 x 25	PH3	250	3.000	<b>4,20</b>
TR81Z63032	6,3 x 32	PH3	250	3.000	<b>4,98</b>
TR81Z63038	6,3 x 38	PH3	250	1.500	<b>5,94</b>
TR81Z63045	6,3 x 45	PH3	250	1.500	<b>6,33</b>
TR81Z63050	6,3 x 50	PH3	250	1.500	<b>7,35</b>
TR81Z63060	6,3 x 60	PH3	100	1.200	<b>8,33</b>
TR81Z63070	6,3 x 70	PH3	100	1.200	<b>9,48</b>
TR81Z63080	6,3 x 80	PH3	100	1.200	<b>11,73</b>
TR81Z63090	6,3 x 90	PH3	50	600	<b>14,85</b>
TR81Z63100	6,3 x 100	PH3	50	600	<b>17,17</b>
TR81Z63110	6,3 x 110	PH3	50	600	<b>18,84</b>
TR81Z63120	6,3 x 120	PH3	50	600	<b>20,21</b>

ASK FOR TECHNICAL INFORMATION / DEMANDEZ INFORMATIONS TECHNIQUES / SOLICITENOS LA FICHA TÉCNICA / SOLICITE A FICHA TÉCNICA PARA MAIS INFORMAÇÕES

# SCREWS

VIS / TORNILLOS / PARAFUSOS

**SELF TAPPING SCREWS DIN-7981, PAN HEAD, PHILLIPS.**  
VIA À TOLE DIN-7981, TÊTE CYLINDRIQUE BOMBÉE, PHILLIPS.  
TORNILLOS ROSCA CHAPA DIN-7981, CABEZA ALOMADA, PHILLIPS.  
PARAFUSO ROSCA DE CHAPA DIN-7981, CABEÇA DE QUEIJO, PHILLIPS

## DIN-7981 BLACK ZINC PLATED

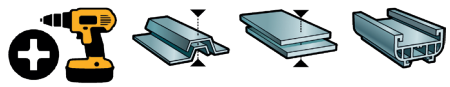

**BLACK ZINC PLATED / ZINGUÉ NOIR / ZINCADO NEGRO / ZINCADO A PRETO**

CODE CÓ-DIGO	SIZE / MESURE MEDIDA	+			€ / 100
TR81N29009	2,9 x 9,5	PH1	1.000	24.000	<b>0,98</b>
TR81N35009	3,5 x 9,5	PH2	1.000	24.000	<b>1,07</b>
TR81N35013	3,5 x 13	PH2	500	15.000	<b>1,38</b>
TR81N35016	3,5 x 16	PH2	500	12.000	<b>1,61</b>
TR81N35019	3,5 x 19	PH2	500	12.000	<b>1,83</b>
TR81N35025	3,5 x 25	PH2	250	6.000	<b>2,49</b>
TR81N42016	4,2 x 16	PH2	500	12.000	<b>2,11</b>
TR81N42019	4,2 x 19	PH2	500	8.000	<b>2,28</b>
TR81N42025	4,2 x 25	PH2	250	6.000	<b>2,75</b>
TR81N42032	4,2 x 32	PH2	250	6.000	<b>3,60</b>

**BLACK ZINC PLATED / ZINGUÉ NOIR / ZINCADO NEGRO / ZINCADO A PRETO**

CODE CÓ-DIGO	SIZE / MESURE MEDIDA	+			€ / 100
TR81N42038	4,2 x 38	PH2	250	3.000	<b>4,08</b>
TR81N48016	4,8 x 16	PH2	250	6.000	<b>3,19</b>
TR81N48019	4,8 x 19	PH2	250	6.000	<b>3,24</b>
TR81N48022	4,8 x 22	PH2	250	6.000	<b>3,45</b>
TR81N48025	4,8 x 25	PH2	250	6.000	<b>3,73</b>
TR81N48032	4,8 x 32	PH2	250	4.000	<b>4,23</b>
TR81N48038	4,8 x 38	PH2	250	3.000	<b>5,04</b>
TR81N48045	4,8 x 45	PH2	250	3.000	<b>6,86</b>
TR81N48050	4,8 x 50	PH2	250	3.000	<b>7,17</b>
TR81N48060	4,8 x 60	PH2	250	1.500	<b>9,28</b>

**SELF TAPPING SCREWS DIN-7981, PAN HEAD, PHILLIPS.**  
VIA À TOLE DIN-7981, TÊTE CYLINDRIQUE BOMBÉE, PHILLIPS.  
TORNILLOS ROSCA CHAPA DIN-7981, CABEZA ALOMADA, PHILLIPS.  
PARAFUSO DIN-7981, CABEÇA QUEIJO, PHILLIPS

## DIN-7981 PAINTED WHITE

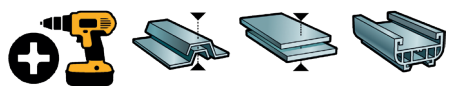

**ZINC  
+  
PAINTED**



**WHITE / BLANC / PINTADO BLANCO / BRANCO**

CODE CÓ-DIGO	SIZE / MESURE MEDIDA	+			€ / 100
TR81B35009	3,5 x 9,5	PH2	1.000	24.000	<b>2,08</b>
TR81B35013	3,5 x 13	PH2	500	15.000	<b>2,73</b>
TR81B35016	3,5 x 16	PH2	500	12.000	<b>3,02</b>
TR81B35025	3,5 x 25	PH2	250	6.000	<b>4,06</b>

**WHITE / BLANC / PINTADO BLANCO / BRANCO**

CODE CÓ-DIGO	SIZE / MESURE MEDIDA	+			€ / 100
TR81B42013	4,2 x 13	PH2	500	12.000	<b>3,74</b>
TR81B42025	4,2 x 25	PH2	250	6.000	<b>5,51</b>
TR81B42032	4,2 x 32	PH2	250	6.000	<b>6,90</b>
TR81B48025	4,8 x 25	PH2	250	6.000	<b>7,60</b>

# TCR

**PVC CAPS FOR HEAD SCREWS DIN-7981 & DIN-7504-N**  
BOUCHONS EN PVC POUR TÊTE VISES DIN-7981 & DIN-7504-N  
TAPONES DE PVC, PARA CABEZAS DE TORNILLOS DIN-7981 & DIN-7504-N  
TAMPAS DE PVC PARA CABEÇA PARAFUSOS DIN-7981 & DIN7504-N

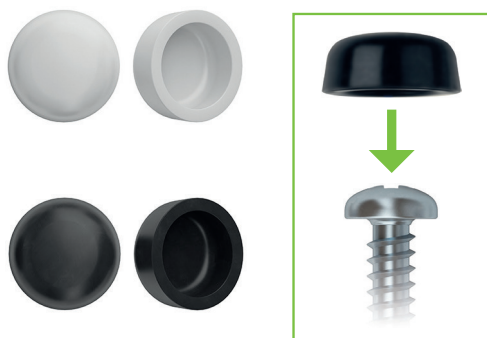

**WHITE - BLANC - BLANCO - BRANCO**

CODE CÓDIGO	SIZE / MESURE / MEDIDA			€ / 100
TCR42B	PARA / FOR / POUR Ø 4,2	1.000	12.000	<b>2,45</b>
TCR48B	PARA / FOR / POUR Ø 4,8	1.000	12.000	<b>2,45</b>
TCR55B	PARA / FOR / POUR Ø 5,5	1.000	6.000	<b>2,45</b>

**BLACK - NOIR - NEGRO - PRETO**

CODE CÓDIGO	SIZE / MESURE / MEDIDA			€ / 100
TCR42N	PARA / FOR / POUR Ø 4,2	1.000	12.000	<b>2,45</b>
TCR48N	PARA / FOR / POUR Ø 4,8	1.000	12.000	<b>2,45</b>
TCR55N	PARA / FOR / POUR Ø 5,5	1.000	6.000	<b>2,45</b>

# DIN-7982

**SELF TAPPING SCREWS, COUNTERSUNK HEAD 80°, PHILLIPS**  
VIS À TOLE, TÊTE FRAISÉE 80°, PHILLIPS  
TORNILLOS ROSCA CHAPA, CABEZA AVELLANADA 80°, PHILLIPS  
PARAFUSO ROSCA DE CHAPA, CABEÇA DE EMBEBER 80°, PHILLIPS

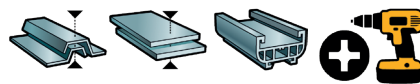
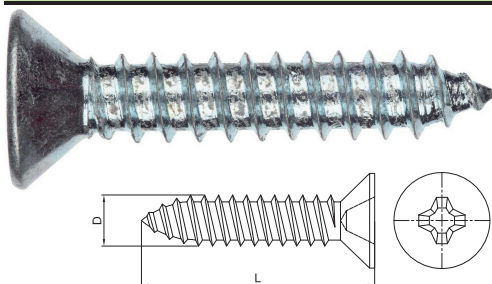

**BITS / EMBOUTS / PUNTAS**

AVAILABLE, SEE PAGE:  
DISPONIBLE, VER PÁGINA:  
DISPONIBLE, VOIR PAGE:  
DISPONÍVEL, VER PÁGINA:

**P. 76**

**AVAILABLE IN RAL COLOURS**



**ZINC PLATED / ZINGUÉ / ZINCADO**

CODE CÓDIGO	SIZE / MESURE / MEDIDA				€ / 100
TR82Z29006	2,9 x 6,5	PH1	1.000	48.000	<b>0,59</b>
TR82Z29009	2,9 x 9,5	PH1	1.000	48.000	<b>0,60</b>
TR82Z29013	2,9 x 13	PH1	1.000	48.000	<b>0,61</b>
TR82Z29016	2,9 x 16	PH1	1.000	24.000	<b>0,65</b>
TR82Z29019	2,9 x 19	PH1	1.000	24.000	<b>0,75</b>
TR82Z29022	2,9 x 22	PH1	1.000	24.000	<b>0,76</b>
TR82Z29025	2,9 x 25	PH1	500	12.000	<b>0,95</b>
TR82Z35009	3,5 x 9,5	PH2	1.000	24.000	<b>0,65</b>
TR82Z35013	3,5 x 13	PH2	500	24.000	<b>0,79</b>
TR82Z35016	3,5 x 16	PH2	500	24.000	<b>0,86</b>
TR82Z35019	3,5 x 19	PH2	500	12.000	<b>1,09</b>
TR82Z35022	3,5 x 22	PH2	500	12.000	<b>1,05</b>
TR82Z35025	3,5 x 25	PH2	250	12.000	<b>1,33</b>
TR82Z35032	3,5 x 32	PH2	250	6.000	<b>1,51</b>
TR82Z35038	3,5 x 38	PH2	250	6.000	<b>1,69</b>
TR82Z39009	3,9 x 9,5	PH2	500	24.000	<b>0,84</b>
TR82Z39013	3,9 x 13	PH2	500	12.000	<b>1,07</b>
TR82Z39016	3,9 x 16	PH2	500	12.000	<b>1,00</b>
TR82Z39019	3,9 x 19	PH2	500	12.000	<b>1,09</b>
TR82Z39022	3,9 x 22	PH2	250	6.000	<b>1,40</b>
TR82Z39025	3,9 x 25	PH2	250	6.000	<b>1,52</b>
TR82Z39032	3,9 x 32	PH2	250	6.000	<b>1,91</b>
TR82Z39038	3,9 x 38	PH2	250	6.000	<b>1,95</b>
TR82Z39045	3,9 x 45	PH2	250	3.000	<b>2,23</b>
TR82Z39050	3,9 x 50	PH2	250	3.000	<b>2,61</b>
TR82Z42013	4,2 x 13	PH2	500	16.000	<b>0,99</b>
TR82Z42016	4,2 x 16	PH2	500	12.000	<b>1,35</b>
TR82Z42019	4,2 x 19	PH2	500	12.000	<b>1,39</b>
TR82Z42022	4,2 x 22	PH2	250	12.000	<b>1,54</b>
TR82Z42025	4,2 x 25	PH2	250	6.000	<b>1,65</b>
TR82Z42032	4,2 x 32	PH2	250	6.000	<b>1,90</b>
TR82Z42038	4,2 x 38	PH2	250	6.000	<b>2,17</b>
TR82Z42045	4,2 x 45	PH2	250	3.000	<b>2,50</b>

**ZINC PLATED / ZINGUÉ / ZINCADO**

CODE CÓDIGO	SIZE / MESURE / MEDIDA				€ / 100
TR82Z42050	4,2 x 50	PH2	250	3.000	<b>2,85</b>
TR82Z42060	4,2 x 60	PH2	250	3.000	<b>3,53</b>
TR82Z42070	4,2 x 70	PH2	250	3.000	<b>4,15</b>
TR82Z48013	4,8 x 13	PH2	500	12.000	<b>1,31</b>
TR82Z48016	4,8 x 16	PH2	250	12.000	<b>1,60</b>
TR82Z48019	4,8 x 19	PH2	250	6.000	<b>1,80</b>
TR82Z48022	4,8 x 22	PH2	250	6.000	<b>1,90</b>
TR82Z48025	4,8 x 25	PH2	250	6.000	<b>2,24</b>
TR82Z48032	4,8 x 32	PH2	250	6.000	<b>2,45</b>
TR82Z48038	4,8 x 38	PH2	250	3.000	<b>3,01</b>
TR82Z48045	4,8 x 45	PH2	250	3.000	<b>3,40</b>
TR82Z48050	4,8 x 50	PH2	250	3.000	<b>4,06</b>
TR82Z48060	4,8 x 60	PH2	250	1.500	<b>4,62</b>
TR82Z48070	4,8 x 70	PH2	100	2.400	<b>5,65</b>
TR82Z55013	5,5 x 13	PH3	250	8.000	<b>1,90</b>
TR82Z55016	5,5 x 16	PH3	250	6.000	<b>2,09</b>
TR82Z55019	5,5 x 19	PH3	250	6.000	<b>2,28</b>
TR82Z55022	5,5 x 22	PH3	250	6.000	<b>2,57</b>
TR82Z55025	5,5 x 25	PH3	250	6.000	<b>2,87</b>
TR82Z55032	5,5 x 32	PH3	250	3.000	<b>3,37</b>
TR82Z55038	5,5 x 38	PH3	250	3.000	<b>3,76</b>
TR82Z55045	5,5 x 45	PH3	250	3.000	<b>4,47</b>
TR82Z55050	5,5 x 50	PH3	250	1.500	<b>5,49</b>
TR82Z55060	5,5 x 60	PH3	100	1.200	<b>6,24</b>
TR82Z55070	5,5 x 70	PH3	100	1.200	<b>7,02</b>
TR82Z63025	6,3 x 25	PH3	250	3.000	<b>4,00</b>
TR82Z63032	6,3 x 32	PH3	250	3.000	<b>5,04</b>
TR82Z63038	6,3 x 38	PH3	250	3.000	<b>5,16</b>
TR82Z63045	6,3 x 45	PH3	250	1.500	<b>5,50</b>
TR82Z63050	6,3 x 50	PH3	250	1.500	<b>6,48</b>
TR82Z63060	6,3 x 60	PH3	100	1.200	<b>9,05</b>
TR82Z63070	6,3 x 70	PH3	100	1.200	<b>9,47</b>

ASK FOR TECHNICAL INFORMATION / DEMANDEZ INFORMATIONS TECHNIQUES / SOLICITENOS LA FICHA TÉCNICA / SOLICITE A FICHA TÉCNICA PARA MAIS INFORMAÇÕES

# SCREWS

VIS / TORNILLOS / PARAFUSOS

## TAMPERPROOF SCREW WITH TX-40 RECESS

VIS INVOLABLE, TX-40

TORNILLO INVOLABLE, HUELLA TX-40

PARAFUSO DE CABEÇA INVOLÁVEL TX-40



# TINV

### ZINC PLATED / ZINGUÉ / ZINCADO

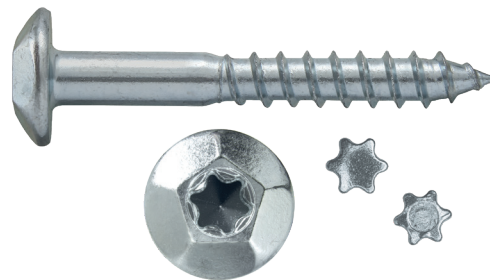
CÓDIGO CODE	SIZE / MESURE MEDIDA		Ø			€ / 100
TINVZ6040	6 x 40	TX40	16,30 - 17,00	100	1.200	13,74
TINVZ6050	6 x 50	TX40	16,30 - 17,00	100	1.200	14,24
TINVZ6060	6 x 60	TX40	16,30 - 17,00	100	600	15,15
TINVZ6070	6 x 70	TX40	16,30 - 17,00	100	600	18,02
TINVZ7030	7 x 30	TX40	16,30 - 17,00	100	1.200	13,09
TINVZ7040	7 x 40	TX40	16,30 - 17,00	100	1.200	13,33
TINVZ7050	7 x 50	TX40	16,30 - 17,00	100	1.200	13,86
TINVZ7060	7 x 60	TX40	16,30 - 17,00	100	600	15,68
TINVZ7070	7 x 70	TX40	16,30 - 17,00	100	600	16,27
TINVZ7080	7 x 80	TX40	16,30 - 17,00	100	600	18,86
TINVZ7090	7 x 90	TX40	16,30 - 17,00	100	600	23,31
TINVZ7105	7 x 105	TX40	16,30 - 17,00	100	600	50,59
TINVZ7120	7 x 120	TX40	16,30 - 17,00	100	600	58,52
TINVZ7140	7 x 140	TX40	16,30 - 17,00	100	600	80,53
TINVZ7165	7 x 165	TX40	16,30 - 17,00	100	400	99,55
TINVZ7205	7 x 205	TX40	16,30 - 17,00	100	300	151,48



### BLACK ZINC PLATED / ZINGUÉ NOIR / ZINCADO NEGRO / ZINCADO PRETO

CÓDIGO CODE	SIZE / MESURE MEDIDA		Ø			€ / 100
TINVN6040	6 x 40	TX40	16,30 - 17,00	100	1.200	16,59
TINVN6050	6 x 50	TX40	16,30 - 17,00	100	1.200	16,81
TINVN6060	6 x 60	TX40	16,30 - 17,00	100	600	18,62
TINVN6070	6 x 70	TX40	16,30 - 17,00	100	600	20,43
TINVN7030	7 x 30	TX40	16,30 - 17,00	100	1.200	19,39
TINVN7040	7 x 40	TX40	16,30 - 17,00	100	1.200	20,43
TINVN7050	7 x 50	TX40	16,30 - 17,00	100	1.200	22,50
TINVN7060	7 x 60	TX40	16,30 - 17,00	100	600	24,96
TINVN7070	7 x 70	TX40	16,30 - 17,00	100	600	26,38
TINVN7080	7 x 80	TX40	16,30 - 17,00	100	600	28,96
TINVN7090	7 x 90	TX40	16,30 - 17,00	100	600	31,03



### STAINLESS STEEL A2 / INOXYDABLE A2 / INOXIDABLE A2 / INOX A2

CÓDIGO CODE	SIZE / MESURE MEDIDA		Ø			€ / 100
TINVI7050	7 x 50	TX40	16,30 - 17,00	100	1.200	52,29
TINVI7060	7 x 60	TX40	16,30 - 17,00	100	600	59,77
TINVI7070	7 x 70	TX40	16,30 - 17,00	100	600	62,63
TINVI7080	7 x 80	TX40	16,30 - 17,00	100	600	69,86



ASK FOR TECHNICAL INFORMATION / DEMANDEZ INFORMATIONS TECHNIQUES / SOLICITENOS LA FICHA TÉCNICA / SOLICITE A FICHA TÉCNICA PARA MAIS INFORMAÇÕES



#### BITS / EMBOUTS / PUNTAS

AVAILABLE, SEE PAGE:  
DISPONIBLE, VOIR PAGE:  
DISPONIBLE, VER PÁGINA:  
DISPONÍVEL, VER PÁGINA:

P. 76



## STAR ZINC ALLOY - FOR TAMPERPROOF SCREW WITH TX-40 RECESS



STAR ZAMAK - POUR VIS INVOLABLE, TX-40

ESTRELLA ZAMAK, PARA TORNILLO INVOLABLE, HUELLA TX-40

ESTRELA ZAMAK, PARAFUSO INVOLÁVEL, CHAVE TX-40



# ESTINV

### ZINC PLATED / ZINGUÉ / ZINCADO

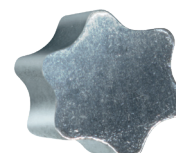
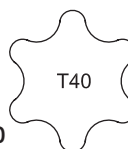
CODE CÓ-DIGO	SIZE / MESURE / MEDIDA			€ / 100
ESTINVZ	STAR / ESTRELLA TX-40	100	1.200	2,66



### BLACK ZINC PLATED / ZINGUÉ NOIR / ZINCADO NEGRO / ZINCADO PRETO

CODE CÓ-DIGO	SIZE / MESURE / MEDIDA			€ / 100
ESTINVN	STAR / ESTRELLA TX-40	100	1.200	3,08

# TBA

## DIN-571

COACH WOOD SCREW, HEXAGON HEAD  
 TIREFOND À VISSER POUR PANNE BOIS, TÊTE HEXAGONALE  
 TORNILLO BARRAQUERO, CABEZA HEXAGONAL  
 PARAFUSO PARA MADEIRA, CABEÇA SEXTAVADA

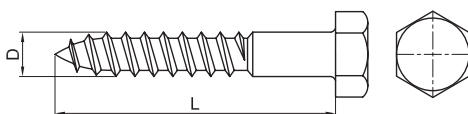
**ZINC PLATED / ZINGUÉ / ZINCADO**

CODE CÓ-DIGO	SIZE / MESURE MEDIDA				€ / 100
TBAZ05030	5 x 30	8	200	4.800	<b>2,76</b>
TBAZ05040	5 x 40	8	200	2.400	<b>3,51</b>
TBAZ05050	5 x 50	8	200	2.400	<b>4,13</b>
TBAZ05060	5 x 60	8	200	2.400	<b>4,71</b>
TBAZ06025	6 x 25	10	200	2.400	<b>3,01</b>
TBAZ06030	6 x 30	10	200	2.400	<b>3,33</b>
TBAZ06035	6 x 35	10	200	2.400	<b>3,82</b>
TBAZ06040	6 x 40	10	200	2.400	<b>4,28</b>
TBAZ06045	6 x 45	10	200	2.400	<b>4,50</b>
TBAZ06050	6 x 50	10	200	2.400	<b>5,02</b>
TBAZ06060	6 x 60	10	200	1.200	<b>6,09</b>
TBAZ06070	6 x 70	10	200	1.200	<b>6,74</b>
TBAZ06080	6 x 80	10	200	1.200	<b>7,31</b>
TBAZ06090	6 x 90	10	100	1.200	<b>8,62</b>
TBAZ06100	6 x 100	10	100	1.200	<b>9,03</b>
TBAZ06110	6 x 110	10	100	1.200	<b>11,90</b>
TBAZ06120	6 x 120	10	100	800	<b>11,82</b>
TBAZ07030	7 x 30	12	200	2.400	<b>5,42</b>
TBAZ07040	7 x 40	12	200	1.600	<b>6,60</b>
TBAZ07050	7 x 50	12	200	1.200	<b>7,67</b>
TBAZ07060	7 x 60	12	100	1.200	<b>9,38</b>
TBAZ07070	7 x 70	12	100	1.200	<b>10,15</b>
TBAZ07080	7 x 80	12	100	800	<b>10,89</b>
TBAZ07090	7 x 90	12	100	400	<b>11,41</b>
TBAZ07100	7 x 100	12	100	600	<b>12,88</b>
TBAZ07120	7 x 120	12	100	600	<b>15,75</b>
TBAZ08030	8 x 30	13	200	1.200	<b>6,38</b>
TBAZ08040	8 x 40	13	200	1.200	<b>7,56</b>
TBAZ08045	8 x 45	13	200	1.200	<b>7,93</b>
TBAZ08050	8 x 50	13	200	1.200	<b>9,10</b>
TBAZ08060	8 x 60	13	200	1.200	<b>10,67</b>
TBAZ08070	8 x 70	13	200	800	<b>12,14</b>
TBAZ08080	8 x 80	13	200	800	<b>13,18</b>
TBAZ08090	8 x 90	13	100	600	<b>14,91</b>
TBAZ08100	8 x 100	13	100	600	<b>16,12</b>
TBAZ08110	8 x 110	13	100	600	<b>16,61</b>
TBAZ08120	8 x 120	13	100	600	<b>18,03</b>

**ZINC PLATED / ZINGUÉ / ZINCADO**

CODE CÓ-DIGO	SIZE / MESURE MEDIDA				€ / 100
TBAZ08130	8 x 130	13	100	400	<b>19,50</b>
TBAZ08140	8 x 140	13	100	400	<b>20,68</b>
TBAZ08150	8 x 150	13	100	400	<b>22,23</b>
TBAZ08160	8 x 160	13	100	400	<b>23,45</b>
TBAZ08180	8 x 180	13	100	300	<b>30,52</b>
TBAZ08200	8 x 200	13	100	300	<b>32,06</b>
TBAZ10040	10 x 40	17	100	600	<b>14,81</b>
TBAZ10050	10 x 50	17	100	600	<b>15,92</b>
TBAZ10060	10 x 60	17	100	600	<b>16,85</b>
TBAZ10070	10 x 70	17	100	600	<b>20,27</b>
TBAZ10080	10 x 80	17	100	400	<b>21,51</b>
TBAZ10090	10 x 90	17	100	400	<b>24,92</b>
TBAZ10100	10 x 100	17	100	400	<b>25,78</b>
TBAZ10110	10 x 110	17	50	300	<b>28,29</b>
TBAZ10120	10 x 120	17	50	300	<b>32,16</b>
TBAZ10130	10 x 130	17	50	300	<b>32,70</b>
TBAZ10140	10 x 140	17	50	300	<b>39,03</b>
TBAZ10150	10 x 150	17	50	200	<b>41,76</b>
TBAZ10160	10 x 160	17	50	200	<b>44,59</b>
TBAZ10180	10 x 180	17	50	150	<b>48,86</b>
TBAZ10200	10 x 200	17	50	150	<b>53,76</b>
TBAZ12060	12 x 60	19	50	300	<b>29,03</b>
TBAZ12070	12 x 70	19	50	300	<b>30,61</b>
TBAZ12080	12 x 80	19	50	300	<b>34,83</b>
TBAZ12090	12 x 90	19	50	300	<b>37,11</b>
TBAZ12100	12 x 100	19	50	300	<b>41,29</b>
TBAZ12120	12 x 120	19	50	200	<b>50,16</b>
TBAZ12130	12 x 130	19	50	100	<b>51,19</b>
TBAZ12140	12 x 140	19	50	100	<b>55,07</b>
TBAZ12150	12 x 150	19	50	200	<b>57,03</b>
TBAZ12160	12 x 160	19	50	200	<b>60,94</b>
TBAZ12180	12 x 180	19	50	150	<b>73,04</b>
TBAZ12200	12 x 200	19	50	150	<b>83,19</b>
TBAZ12220	12 x 220	19	25	100	<b>90,75</b>
TBAZ12240	12 x 240	19	25	100	<b>97,34</b>
TBAZ12260	12 x 260	19	25	100	<b>106,70</b>
TBAZ14100	14 x 100	22	50	200	<b>70,08</b>

ASK FOR TECHNICAL INFORMATION / DEMANDEZ INFORMATIONS TECHNIQUES / SOLICITENOS LA FICHA TÉCNICA / SOLICITE A FICHA TÉCNICA PARA MAIS INFORMAÇÕES

# TBH

MAGNETIC HEXAGONAL NUT SETTER  
 PORTE-EMBOUT HEXAG. MAGNÉTIQUE  
 BOCAS HEXAGONALES MAGNÉTICAS  
 PORTA-BITS HEXAG. MAGNÉTICO



CODE CÓ-DIGO	SIZE / MESURE MEDIDA				€ / 100
TBH006	1/4" - 6 mm	6	5	240	<b>399,70</b>
TBH007	1/4" - 7 mm	7	5	240	<b>399,70</b>
TBH008	1/4" - 8 mm	8	5	240	<b>399,70</b>
TBH010	1/4" - 10 mm	10	5	240	<b>399,70</b>

# SCREWS

VIS / TORNILLOS / PARAFUSOS

COACH WOOD SCREW, HEXAGON HEAD, FULL THREAD  
TIREFOND À VISSER POUR PANNE BOIS, TÊTE HEXAGONALE, FILETAGE TOTAL  
TORNILLO BARRAQUERO, CABEZA HEXAGONAL, ROSCA TOTAL  
PARAFUSO PARA MADEIRA, CABEÇA SEXTAVADA, ROSCA TOTAL

## TBA-RT

DIN-571

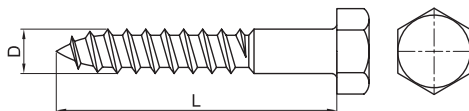

ZINC PLATED / ZINGUÉ / ZINCADO

CODE CÓDIGO	SIZE / MESURE MEDIDA				€ / 100
TBART06050	6 x 50	10	200	2.400	<b>5,54</b>
TBART06060	6 x 60	10	200	1.200	<b>6,51</b>
TBART06070	6 x 70	10	200	1.200	<b>7,40</b>
TBART08050	8 x 50	13	200	1.200	<b>10,05</b>
TBART08060	8 x 60	13	200	1.200	<b>11,41</b>
TBART08070	8 x 70	13	200	800	<b>13,08</b>
TBART08080	8 x 80	13	200	800	<b>14,55</b>
TBART10060	10 x 60	17	100	600	<b>18,76</b>
TBART10080	10 x 80	17	100	400	<b>24,82</b>

ASK FOR TECHNICAL INFORMATION / DEMANDEZ INFORMATIONS TECHNIQUES / SOLICITENOS LA FICHA TÉCNICA / SOLICITE A FICHA TÉCNICA PARA MAIS INFORMAÇÕES

COACH WOOD SCREW, HEXAGON HEAD, **STAINLESS STEEL A2**  
TIREFOND À VISSER POUR PANNE BOIS, TÊTE HEXAGONALE, **INOXYDABLE A2**  
TORNILLO BARRAQUERO, CABEZA HEXAGONAL, **INOX A2**  
PARAFUSO PARA MADEIRA, CABEÇA SEXTAVADA, **INOX A2**

## TBA-INOX

DIN-571

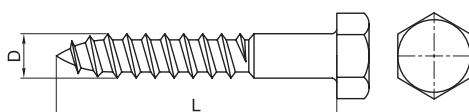

STAINLESS STEEL A2 / INOXYDABLE A2 / INOXIDABLE A2 / INOX A2

CODE CÓDIGO	SIZE / MESURE MEDIDA				€ / 100
TBAI06040	6 x 40	10	200	2.400	<b>10,27</b>
TBAI06050	6 x 50	10	200	2.400	<b>11,90</b>
TBAI06060	6 x 60	10	200	1.200	<b>14,16</b>
TBAI06070	6 x 70	10	200	1.200	<b>15,73</b>
TBAI08050	8 x 50	13	200	1.200	<b>23,05</b>
TBAI08060	8 x 60	13	200	1.200	<b>26,39</b>
TBAI08070	8 x 70	13	200	800	<b>30,02</b>
TBAI08080	8 x 80	13	200	800	<b>33,84</b>
TBAI10080	10 x 80	17	100	400	<b>147,87</b>



ASK FOR TECHNICAL INFORMATION / DEMANDEZ INFORMATIONS TECHNIQUES / SOLICITENOS LA FICHA TÉCNICA / SOLICITE A FICHA TÉCNICA PARA MAIS INFORMAÇÕES

# TTXEB

TX FLAT HEAD CHIPBOARD SCREWS WITH SERRATION AND DRILLING POINT "TYPE 17"

VIS À BOIS, TX, TÊTE FRAISÉE, AVEC SERRAGE ET POINTE FOREUSE "TYPE 17"

TIRAFONDOS PARA MADERA, CABEZA AVELLANADA, HUELLA TX, AUTOTALADRANTES PUNTA "TYPE 17"

PARAFUSO CABEÇA DE EMBEBER, PARA MADEIRA, COM PONTA PERFORANTE "TIPO 17"



**Free  
Gratuit  
Gratis**

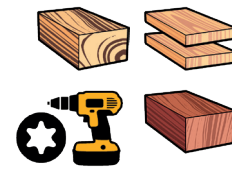

YELLOW ZINC PLATED - BICHROMATÉ - BICROMATADO - PASS.AMARELO

CODE CÓ-DIGO	SIZE / MESURE MEDIDA				€ / 100
TTXEB30016	3,0 x 16	TX10	1.000	24.000	<b>1,21</b>
TTXEB30020	3,0 x 20	TX10	1.000	24.000	<b>1,30</b>
TTXEB30025	3,0 x 25	TX10	500	12.000	<b>1,71</b>
TTXEB30030	3,0 x 30	TX10	500	12.000	<b>1,84</b>
TTXEB30035	3,0 x 35	TX10	500	12.000	<b>1,98</b>
TTXEB30040	3,0 x 40	TX10	500	6.000	<b>2,24</b>
TTXEB35016	3,5 x 16	TX15	1.000	24.000	<b>1,47</b>
TTXEB35020	3,5 x 20	TX15	1.000	12.000	<b>1,51</b>
TTXEB35025	3,5 x 25	TX15	500	12.000	<b>1,96</b>
TTXEB35030	3,5 x 30	TX15	500	12.000	<b>2,11</b>
TTXEB35035	3,5 x 35	TX15	500	6.000	<b>2,31</b>
TTXEB35040	3,5 x 40	TX15	500	6.000	<b>2,54</b>
TTXEB35045	3,5 x 45	TX15	200	4.800	<b>3,31</b>
TTXEB35050	3,5 x 50	TX15	200	2.400	<b>3,43</b>
TTXEB35060	3,5 x 60	TX15	200	2.400	<b>4,67</b>
TTXEB40016	4,0 x 16	TX20	500	24.000	<b>1,77</b>
TTXEB40020	4,0 x 20	TX20	500	12.000	<b>1,91</b>
TTXEB40025	4,0 x 25	TX20	500	12.000	<b>2,20</b>
TTXEB40030	4,0 x 30	TX20	500	6.000	<b>2,49</b>
TTXEB40035	4,0 x 35	TX20	500	6.000	<b>2,72</b>
TTXEB40040	4,0 x 40	TX20	500	6.000	<b>2,97</b>
TTXEB40045	4,0 x 45	TX20	500	3.000	<b>3,55</b>
TTXEB40050	4,0 x 50	TX20	200	4.800	<b>4,07</b>
TTXEB40060	4,0 x 60	TX20	200	4.800	<b>4,81</b>
TTXEB40070	4,0 x 70	TX20	200	1.200	<b>5,37</b>
TTXEB45030	4,5 x 30	TX25	500	6.000	<b>2,86</b>
TTXEB45035	4,5 x 35	TX25	200	4.800	<b>3,75</b>
TTXEB45040	4,5 x 40	TX25	200	2.400	<b>4,05</b>
TTXEB45045	4,5 x 45	TX25	200	2.400	<b>4,38</b>
TTXEB45050	4,5 x 50	TX25	200	2.400	<b>4,80</b>
TTXEB45060	4,5 x 60	TX25	200	2.400	<b>5,69</b>
TTXEB45070	4,5 x 70	TX25	200	1.200	<b>6,99</b>
TTXEB45080	4,5 x 80	TX25	200	1.200	<b>8,93</b>
TTXEB50030	5,0 x 30	TX25	200	4.800	<b>3,98</b>
TTXEB50035	5,0 x 35	TX25	200	2.400	<b>4,27</b>
TTXEB50040	5,0 x 40	TX25	200	2.400	<b>4,78</b>
TTXEB50045	5,0 x 45	TX25	200	2.400	<b>5,22</b>
TTXEB50050	5,0 x 50	TX25	200	2.400	<b>7,92</b>
TTXEB50060	5,0 x 60	TX25	200	1.200	<b>6,86</b>
TTXEB50070	5,0 x 70	TX25	200	1.200	<b>7,27</b>
TTXEB50080	5,0 x 80	TX25	200	1.200	<b>9,31</b>
TTXEB50090	5,0 x 90	TX25	100	1.200	<b>10,22</b>
TTXEB50100	5,0 x 100	TX25	100	1.200	<b>12,69</b>
TTXEB50110	5,0 x 110	TX25	100	1.200	<b>12,72</b>
TTXEB50120	5,0 x 120	TX25	100	1.200	<b>14,57</b>
TTXEB60040	6,0 x 40	TX30	200	2.400	<b>7,50</b>
TTXEB60045	6,0 x 45	TX30	200	2.400	<b>8,00</b>
TTXEB60050	6,0 x 50	TX30	200	1.200	<b>8,69</b>
TTXEB60060	6,0 x 60	TX30	200	1.200	<b>9,74</b>
TTXEB60070	6,0 x 70	TX30	200	1.200	<b>10,79</b>
TTXEB60080	6,0 x 80	TX30	200	1.200	<b>13,85</b>
TTXEB60090	6,0 x 90	TX30	100	1.200	<b>16,29</b>
TTXEB60100	6,0 x 100	TX30	100	1.200	<b>16,12</b>
TTXEB60110	6,0 x 110	TX30	100	600	<b>22,33</b>

CODE CÓ-DIGO	SIZE / MESURE MEDIDA				€ / 100
TTXEB60120	6,0 x 120	TX30	100	600	<b>25,52</b>
TTXEB60130	6,0 x 130	TX30	100	600	<b>25,74</b>
TTXEB60140	6,0 x 140	TX30	100	600	<b>30,49</b>
TTXEB60150	6,0 x 150	TX30	100	600	<b>34,65</b>
TTXEB60160	6,0 x 160	TX30	100	400	<b>42,97</b>
TTXEB60180	6,0 x 180	TX30	100	300	<b>54,22</b>
TTXEB60200	6,0 x 200	TX30	100	300	<b>69,88</b>
TTXEB60220	6,0 x 220	TX30	100	300	<b>77,01</b>
TTXEB60240	6,0 x 240	TX30	100	800	<b>87,18</b>
TTXEB60260	6,0 x 260	TX30	100	800	<b>103,49</b>
TTXEB60280	6,0 x 280	TX30	100	800	<b>115,12</b>
TTXEB60300	6,0 x 300	TX30	100	800	<b>123,38</b>
TTXEB80050	8,0 x 50	TX40	100	1.200	<b>16,76</b>
TTXEB80060	8,0 x 60	TX40	100	1.200	<b>18,86</b>
TTXEB80070	8,0 x 70	TX40	100	1.200	<b>21,43</b>
TTXEB80080	8,0 x 80	TX40	100	1.200	<b>27,40</b>
TTXEB80090	8,0 x 90	TX40	100	1.200	<b>27,68</b>
TTXEB80100	8,0 x 100	TX40	100	1.200	<b>27,91</b>
TTXEB80120	8,0 x 120	TX40	100	1.200	<b>43,61</b>
TTXEB80140	8,0 x 140	TX40	100	600	<b>44,31</b>
TTXEB80150	8,0 x 150	TX40	100	600	<b>48,34</b>
TTXEB80160	8,0 x 160	TX40	100	400	<b>52,94</b>
TTXEB80180	8,0 x 180	TX40	100	300	<b>68,92</b>
TTXEB80200	8,0 x 200	TX40	100	300	<b>74,45</b>
TTXEB80220	8,0 x 220	TX40	100	300	<b>86,63</b>
TTXEB80240	8,0 x 240	TX40	50	450	<b>103,93</b>
TTXEB80250	8,0 x 250	TX40	50	450	<b>114,59</b>
TTXEB80260	8,0 x 260	TX40	50	450	<b>118,49</b>
TTXEB80280	8,0 x 280	TX40	50	450	<b>127,18</b>
TTXEB80300	8,0 x 300	TX40	50	450	<b>142,42</b>
TTXEB80320	8,0 x 320	TX40	50	450	<b>160,65</b>
TTXEB80340	8,0 x 340	TX40	50	450	<b>188,76</b>
TTXEB80350	8,0 x 350	TX40	50	450	<b>180,04</b>
TTXEB80360	8,0 x 360	TX40	50	450	<b>208,55</b>
TTXEB80380	8,0 x 380	TX40	50	450	<b>228,47</b>
TTXEB80400	8,0 x 400	TX40	50	450	<b>244,86</b>
TTXEB10080	10,0 x 080	TX40	50	300	<b>43,23</b>
TTXEB10100	10,0 x 100	TX40	50	300	<b>54,82</b>
TTXEB10120	10,0 x 120	TX40	50	300	<b>68,72</b>
TTXEB10140	10,0 x 140	TX40	50	300	<b>82,90</b>
TTXEB10160	10,0 x 160	TX40	50	200	<b>96,81</b>
TTXEB10180	10,0 x 180	TX40	50	150	<b>130,15</b>
TTXEB10200	10,0 x 200	TX40	50	150	<b>146,20</b>
TTXEB10220	10,0 x 220	TX40	50	150	<b>161,42</b>
TTXEB10240	10,0 x 240	TX40	40	360	<b>178,08</b>
TTXEB10250	10,0 x 250	TX40	40	360	<b>186,97</b>
TTXEB10260	10,0 x 260	TX40	40	360	<b>190,19</b>
TTXEB10280	10,0 x 280	TX40	40	360	<b>208,95</b>
TTXEB10300	10,0 x 300	TX40	40	360	<b>220,08</b>
TTXEB10320	10,0 x 320	TX40	40	360	<b>246,54</b>
TTXEB10340	10,0 x 340	TX40	40	360	<b>260,96</b>
TTXEB10350	10,0 x 350	TX40	40	360	<b>270,48</b>
TTXEB10360	10,0 x 360	TX40	40	360	<b>280,56</b>
TTXEB10380	10,0 x 380	TX40	40	360	<b>302,05</b>
TTXEB10400	10,0 x 400	TX40	40	360	<b>322,21</b>

ASK FOR TECHNICAL INFORMATION / DEMANDEZ INFORMATIONS TECHNIQUES / SOLICITENOS LA FICHA TÉCNICA / SOLICITE A FICHA TÉCNICA PARA MAIS INFORMAÇÕES

# SCREWS

VIS / TORNILLOS / PARAFUSOS

TX FLAT HEAD CHIPBOARD SCREWS, DRILLING POINT "TYPE 17", **STAINLESS STEEL A2**

VIS À BOIS, TX, TÊTE FRAISÉE, POINTE FOREUSE "TYPE 17", **INOXYDABLE A2**

TIRAFONDOS CABEZA AVELLANADA, HUELLA TX, PUNTA "TYPE 17", **INOXIDABLE A2**

PARAFUSO CABEÇA DE EMBEBER, PARA MADEIRA, COM PONTA PERFORANTE "TIPO 17", **INOX A2**

## TTXE-A2

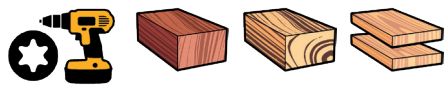

STAINLESS STEEL A2 / INOXYDABLE A2 / INOXIDABLE A2 / INOX A2

CODE CÓDIGO	SIZE / MESURE MEDIDA				€ / 100
TTXEI50050	5 x 50	TX25	200	2.400	<b>16,01</b>
TTXEI50060	5 x 60	TX25	200	1.200	<b>18,56</b>
TTXEI50070	5 x 70	TX25	200	1.200	<b>21,04</b>



Free  
Gratuit  
Gratis



CHIPBOARD SCREW, POZIDRIV, COUNTERSUNK 90° HEAD, THREAD 40°, SPECIAL COATING

VIS À BOIS, POZIDRIV, TÊTE FRAISÉE 90°, FILET 40°, REVÊTEMENT AVEC LUBRIFICACION

TIRAFONDO POZIDRIV, CABEZA 90° AVELLANADA, FILETE 40°, LUBRIFICADO

PARAFUSO POZIDRIVE, CABEÇA DE EMBEBER, ROSCA 90°, LUBRIFICADO

## TPOB

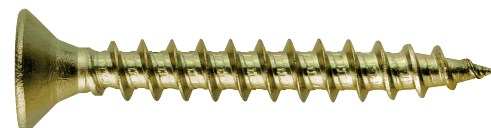
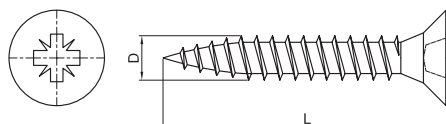

YELLOW ZINC PLATED - BICHROMATÉ - BICROMATADO - PASS.AMARELO

CODE CÓDIGO	SIZE / MESURE MEDIDA				€ / 100
TPOB25010	2,5 x 10	PZ1	1.000	48.000	<b>0,51</b>
TPOB25012	2,5 x 12	PZ1	1.000	48.000	<b>0,52</b>
TPOB25016	2,5 x 16	PZ1	1.000	48.000	<b>0,56</b>
TPOB25020	2,5 x 20	PZ1	1.000	24.000	<b>0,64</b>
TPOB25025	2,5 x 25	PZ1	1.000	24.000	<b>0,70</b>
TPOB30012	3,0 x 12	PZ1	1.000	48.000	<b>0,43</b>
TPOB30016	3,0 x 16	PZ1	1.000	24.000	<b>0,53</b>
TPOB30020	3,0 x 20	PZ1	1.000	24.000	<b>0,60</b>
TPOB30025	3,0 x 25	PZ1	1.000	12.000	<b>0,70</b>
TPOB30030	3,0 x 30	PZ1	1.000	12.000	<b>0,74</b>
TPOB30040	3,0 x 40	PZ1	1.000	6.000	<b>0,99</b>
TPOB35016	3,5 x 16	PZ2	1.000	24.000	<b>0,58</b>
TPOB35020	3,5 x 20	PZ2	1.000	12.000	<b>0,69</b>
TPOB35025	3,5 x 25	PZ2	1.000	12.000	<b>0,79</b>
TPOB35030	3,5 x 30	PZ2	1.000	12.000	<b>0,86</b>
TPOB35035	3,5 x 35	PZ2	500	6.000	<b>1,12</b>
TPOB35040	3,5 x 40	PZ2	500	6.000	<b>1,23</b>
TPOB35050	3,5 x 50	PZ2	250	3.000	<b>1,61</b>
TPOB40016	4,0 x 16	PZ2	1.000	16.000	<b>0,76</b>
TPOB40020	4,0 x 20	PZ2	1.000	12.000	<b>0,88</b>
TPOB40025	4,0 x 25	PZ2	1.000	12.000	<b>1,00</b>
TPOB40030	4,0 x 30	PZ2	500	6.000	<b>1,17</b>
TPOB40035	4,0 x 35	PZ2	500	6.000	<b>1,33</b>
TPOB40040	4,0 x 40	PZ2	500	6.000	<b>1,42</b>
TPOB40045	4,0 x 45	PZ2	500	3.000	<b>1,75</b>
TPOB40050	4,0 x 50	PZ2	250	3.000	<b>1,97</b>
TPOB40060	4,0 x 60	PZ2	250	3.000	<b>2,24</b>
TPOB40070	4,0 x 70	PZ2	250	1.500	<b>2,81</b>
TPOB45020	4,5 x 20	PZ2	500	12.000	<b>1,09</b>
TPOB45025	4,5 x 25	PZ2	500	6.000	<b>1,30</b>
TPOB45030	4,5 x 30	PZ2	500	6.000	<b>1,54</b>
TPOB45035	4,5 x 35	PZ2	500	6.000	<b>1,64</b>
TPOB45040	4,5 x 40	PZ2	500	3.000	<b>1,81</b>

CODE CÓDIGO	SIZE / MESURE MEDIDA				€ / 100
TPOB45045	4,5 x 45	PZ2	250	3.000	<b>2,28</b>
TPOB45050	4,5 x 50	PZ2	250	3.000	<b>2,43</b>
TPOB45060	4,5 x 60	PZ2	250	3.000	<b>2,86</b>
TPOB45070	4,5 x 70	PZ2	250	1.500	<b>3,43</b>
TPOB45080	4,5 x 80	PZ2	100	1.200	<b>4,29</b>
TPOB50020	5,0 x 20	PZ2	500	6.000	<b>1,41</b>
TPOB50025	5,0 x 25	PZ2	500	6.000	<b>1,64</b>
TPOB50030	5,0 x 30	PZ2	250	6.000	<b>1,88</b>
TPOB50035	5,0 x 35	PZ2	250	3.000	<b>2,10</b>
TPOB50040	5,0 x 40	PZ2	250	3.000	<b>2,31</b>
TPOB50045	5,0 x 45	PZ2	250	3.000	<b>2,66</b>
TPOB50050	5,0 x 50	PZ2	250	3.000	<b>2,81</b>
TPOB50060	5,0 x 60	PZ2	250	1.500	<b>3,49</b>
TPOB50070	5,0 x 70	PZ2	100	1.200	<b>4,32</b>
TPOB50080	5,0 x 80	PZ2	100	1.200	<b>4,92</b>
TPOB50090	5,0 x 90	PZ2	100	1.200	<b>5,74</b>
TPOB50100	5,0 x 100	PZ2	100	1.200	<b>6,32</b>
TPOB50120	5,0 x 120	PZ2	100	1.200	<b>9,35</b>
TPOB60040	6,0 x 40	PZ3	250	3.000	<b>3,49</b>
TPOB60050	6,0 x 50	PZ3	250	1.500	<b>4,02</b>
TPOB60060	6,0 x 60	PZ3	250	1.500	<b>4,77</b>
TPOB60070	6,0 x 70	PZ3	100	1.200	<b>6,13</b>
TPOB60080	6,0 x 80	PZ3	100	1.200	<b>6,88</b>
TPOB60090	6,0 x 90	PZ3	100	1.200	<b>7,84</b>
TPOB60100	6,0 x 100	PZ3	100	1.200	<b>9,10</b>
TPOB60110	6,0 x 110	PZ3	100	600	<b>10,76</b>
TPOB60120	6,0 x 120	PZ3	100	600	<b>11,44</b>
TPOB60130	6,0 x 130	PZ3	100	600	<b>13,42</b>
TPOB60140	6,0 x 140	PZ3	100	600	<b>14,95</b>
TPOB60150	6,0 x 150	PZ3	100	600	<b>16,33</b>
TPOB60160	6,0 x 160	PZ3	100	400	<b>18,20</b>
TPOB60180	6,0 x 180	PZ3	100	300	<b>26,62</b>
TPOB60200	6,0 x 200	PZ3	100	300	<b>34,66</b>
TPOB60220	6,0 x 220	PZ3	100	300	<b>49,07</b>

ASK FOR TECHNICAL INFORMATION / DEMANDEZ INFORMATIONS TECHNIQUES / SOLICITENOS LA FICHA TÉCNICA / SOLICITE A FICHA TÉCNICA PARA MAIS INFORMAÇÕES

# TPOZ

**CHIPBOARD SCREW, POZIDRIVE, COUNTERSUNK 90° HEAD, THREAD 40°, SPECIAL COATING**  
VIS À BOIS, POZIDRIVE, TÊTE FRAISÉE 90°, FILET 40°, REVÊTEMENT AVEC LUBRIFICACION  
TIRAFONDO POZIDRIVE, CABEZA 90° AVELLANADA, FILETE 40°, LUBRIFICADO  
PARAFUSO POZIDRIVE, CABEÇA DE EMBEBER, ROSCA 40°, LUBRIFICADO

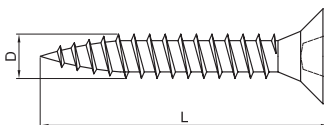
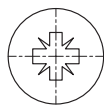

## ZINC PLATED / ZINGUÉ / ZINCADO

CODE CÓ-DIGO	SIZE / MESURE MEDIDA				€ / 100
TPOZ25010	2,5 x 10	PZ1	1.000	48.000	<b>0,50</b>
TPOZ25012	2,5 x 12	PZ1	1.000	48.000	<b>0,51</b>
TPOZ25016	2,5 x 16	PZ1	1.000	48.000	<b>0,56</b>
TPOZ25020	2,5 x 20	PZ1	1.000	24.000	<b>0,64</b>
TPOZ25025	2,5 x 25	PZ1	1.000	24.000	<b>0,70</b>
TPOZ30012	3,0 x 12	PZ1	1.000	48.000	<b>0,45</b>
TPOZ30016	3,0 x 16	PZ1	1.000	24.000	<b>0,53</b>
TPOZ30020	3,0 x 20	PZ1	1.000	24.000	<b>0,60</b>
TPOZ30025	3,0 x 25	PZ1	1.000	12.000	<b>0,70</b>
TPOZ30030	3,0 x 30	PZ1	1.000	12.000	<b>0,74</b>
TPOZ30040	3,0 x 40	PZ1	1.000	6.000	<b>0,97</b>
TPOZ35010	3,5 x 10	PZ2	1.000	24.000	<b>1,02</b>
TPOZ35012	3,5 x 12	PZ2	1.000	24.000	<b>0,86</b>
TPOZ35016	3,5 x 16	PZ2	1.000	24.000	<b>0,58</b>
TPOZ35020	3,5 x 20	PZ2	1.000	12.000	<b>0,72</b>
TPOZ35025	3,5 x 25	PZ2	1.000	12.000	<b>0,79</b>
TPOZ35030	3,5 x 30	PZ2	1.000	12.000	<b>0,86</b>
TPOZ35035	3,5 x 35	PZ2	500	6.000	<b>1,12</b>
TPOZ35040	3,5 x 40	PZ2	500	6.000	<b>1,23</b>
TPOZ35050	3,5 x 50	PZ2	250	3.000	<b>1,61</b>
TPOZ40016	4,0 x 16	PZ2	1.000	16.000	<b>0,76</b>
TPOZ40020	4,0 x 20	PZ2	1.000	12.000	<b>0,88</b>
TPOZ40025	4,0 x 25	PZ2	1.000	12.000	<b>1,00</b>
TPOZ40030	4,0 x 30	PZ2	500	6.000	<b>1,17</b>
TPOZ40035	4,0 x 35	PZ2	500	6.000	<b>1,33</b>
TPOZ40040	4,0 x 40	PZ2	500	6.000	<b>1,42</b>
TPOZ40045	4,0 x 45	PZ2	500	3.000	<b>1,75</b>
TPOZ40050	4,0 x 50	PZ2	250	3.000	<b>1,97</b>
TPOZ40060	4,0 x 60	PZ2	250	3.000	<b>2,24</b>
TPOZ40070	4,0 x 70	PZ2	250	1.500	<b>2,81</b>
TPOZ45020	4,5 x 20	PZ2	500	12.000	<b>1,09</b>
TPOZ45025	4,5 x 25	PZ2	500	6.000	<b>1,30</b>
TPOZ45030	4,5 x 30	PZ2	500	6.000	<b>1,54</b>
TPOZ45035	4,5 x 35	PZ2	500	6.000	<b>1,64</b>

## ZINC PLATED / ZINGUÉ / ZINCADO

CODE CÓ-DIGO	SIZE / MESURE MEDIDA				€ / 100
TPOZ45040	4,5 x 40	PZ2	500	3.000	<b>1,81</b>
TPOZ45045	4,5 x 45	PZ2	250	3.000	<b>2,28</b>
TPOZ45050	4,5 x 50	PZ2	250	3.000	<b>2,43</b>
TPOZ45060	4,5 x 60	PZ2	250	3.000	<b>2,86</b>
TPOZ45070	4,5 x 70	PZ2	250	1.500	<b>3,43</b>
TPOZ45080	4,5 x 80	PZ2	100	1.200	<b>4,29</b>
TPOZ50020	5,0 x 20	PZ2	500	6.000	<b>1,41</b>
TPOZ50025	5,0 x 25	PZ2	500	6.000	<b>1,64</b>
TPOZ50030	5,0 x 30	PZ2	250	6.000	<b>1,88</b>
TPOZ50035	5,0 x 35	PZ2	250	3.000	<b>2,10</b>
TPOZ50040	5,0 x 40	PZ2	250	3.000	<b>2,31</b>
TPOZ50045	5,0 x 45	PZ2	250	3.000	<b>2,66</b>
TPOZ50050	5,0 x 50	PZ2	250	3.000	<b>2,81</b>
TPOZ50060	5,0 x 60	PZ2	250	1.500	<b>3,49</b>
TPOZ50070	5,0 x 70	PZ2	100	1.200	<b>4,32</b>
TPOZ50080	5,0 x 80	PZ2	100	1.200	<b>4,92</b>
TPOZ50090	5,0 x 90	PZ2	100	1.200	<b>5,74</b>
TPOZ50100	5,0 x100	PZ2	100	1.200	<b>6,32</b>
TPOZ50120	5,0 x120	PZ2	100	1.200	<b>9,35</b>
TPOZ60040	6,0 x 40	PZ3	250	3.000	<b>3,49</b>
TPOZ60050	6,0 x 50	PZ3	250	1.500	<b>4,02</b>
TPOZ60060	6,0 x 60	PZ3	250	1.500	<b>4,77</b>
TPOZ60070	6,0 x 70	PZ3	100	1.200	<b>6,13</b>
TPOZ60080	6,0 x 80	PZ3	100	1.200	<b>6,88</b>
TPOZ60090	6,0 x 90	PZ3	100	1.200	<b>7,84</b>
TPOZ60100	6,0 x100	PZ3	100	1.200	<b>9,10</b>
TPOZ60110	6,0 x110	PZ3	100	600	<b>10,76</b>

**PVC SCREW COVERS/CACHE-VIS EN PVC/TAPAS PVC/TAMPAS PVC** P. 76  
AVAILABLE, SEE PAGE:/DISPONIBLE, VOIR PAGE:/DISPONIBLE, VER PÁGINA: /DISPONÍVEL

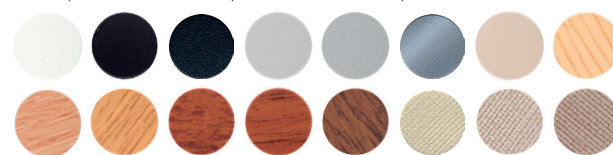

# TPO-INOX

**CHIPBOARD SCREW, POZIDRIV, COUNTERSUNK 90° HEAD, THREAD 40°, STAINLESS STEEL A2**  
VIS À BOIS, POZIDRIV, TÊTE FRAISÉE 90°, FILET 40°, REVÊTEMENT AVEC LUBRIFICACION, **INOX A2**  
TIRAFONDO POZIDRIV, CABEZA 90° AVELLANADA, FILETE 40°, LUBRIFICADO, **INOX A2**  
PARAFUSO POZIDRIVE, CABEÇA DE EMBEBER, ROSCA 40°, LUBRIFICADO, **INOX A2**

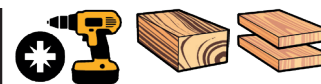
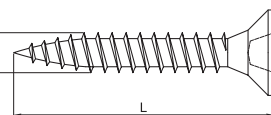
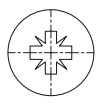

## STAINLESS STEEL A2 / INOXYDABLE A2 / INOXIDABLE A2 / INOX A2

CODE CÓ-DIGO	SIZE / MESURE MEDIDA				€ / 100
TPOI23016	3,0 x 16	PZ1	200	9.600	<b>2,44</b>
TPOI23025	3,0 x 25	PZ1	200	9.600	<b>3,10</b>
TPOI23520	3,5 x 20	PZ2	200	9.600	<b>4,12</b>
TPOI23525	3,5 x 25	PZ2	200	9.600	<b>4,45</b>
TPOI23530	3,5 x 30	PZ2	200	9.600	<b>5,49</b>
TPOI23540	3,5 x 40	PZ2	200	9.600	<b>7,81</b>
TPOI24030	4,0 x 30	PZ2	200	9.600	<b>6,74</b>

CODE CÓ-DIGO	SIZE / MESURE MEDIDA				€ / 100
TPOI24040	4,0 x 40	PZ2	200	9.600	<b>7,96</b>
TPOI24050	4,0 x 50	PZ2	200	4.800	<b>12,50</b>
TPOI24530	4,5 x 30	PZ2	200	9.600	<b>7,91</b>
TPOI24540	4,5 x 40	PZ2	200	9.600	<b>10,17</b>
TPOI24550	4,5 x 50	PZ2	200	4.800	<b>12,65</b>
TPOI25050	5,0 x 50	PZ2	200	4.800	<b>15,72</b>
TPOI25070	5,0 x 70	PZ2	200	2.400	<b>21,43</b>

# SCREWS

VIS / TORNILLOS / PARAFUSOS

## DRYWALL SCREW FOR PLASTERBOARD, TWINFAST THREAD, BUGLE HEAD, S POINT

VIS POUR PLAQUES DE PLÂTRE, DOUBLE FILET, TÊTE TROMPETTE, POINTE CLOU

TORNILLO PARA PLACAS DE CARTÓN-YESO, CABEZA TROMPETA, ROSCA DOBLE HILO, PUNTA S

PARAFUSO PLADUR PARA GESSO CARTONADO, CABEÇA DE EMBEBER, ROSCA HI-LO, PONTA S

# TPL

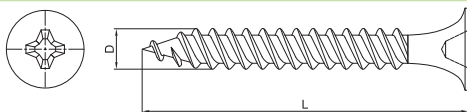

BLACK PHOSPHATED - PHOSPHATÉ - FOSFATADO

CODE CÓDIGO	SIZE / MESURE MEDIDA	+	CAPACIDAD CAPACITY / CAPACITÉ	PRICE	PRICE	€ / 100
TPLN35025	3,5 x 25	PH2	0,60	1.000	12.000	1,45
TPLN35035	3,5 x 35	PH2	0,60	1.000	6.000	1,85
TPLN35045	3,5 x 45	PH2	0,60	500	3.000	2,45
TPLN35055	3,5 x 55	PH2	0,60	500	3.000	2,95
TPLN39025	3,9 x 25	PH2	0,60	1.000	12.000	1,78
TPLN39038	3,9 x 38	PH2	0,60	1.000	6.000	2,60
TPLN39048	3,9 x 48	PH2	0,60	500	3.000	2,95
TPLN39058	3,9 x 58	PH2	0,60	500	3.000	4,10
TPLN42065	4,2 x 65	PH2	0,60	500	3.000	4,65

ZINC PLATED / ZINGUÉ / ZINCADO

CODE CÓDIGO	SIZE / MESURE MEDIDA	+	CAPACIDAD CAPACITY / CAPACITÉ	PRICE	PRICE	€ / 100
TPLZ42075	4,2 x 75	PH2	0,60	500	2.000	4,90
TPLZ48090	4,8 x 90	PH2	0,60	500	1.500	11,15
TPLZ48100	4,8 x 100	PH2	0,60	250	1.000	13,45
TPLZ48110	4,8 x 110	PH2	0,60	250	1.000	14,90
TPLZ48120	4,8 x 120	PH2	0,60	250	1.000	16,50
TPLZ48130	4,8 x 130	PH2	0,60	250	1.000	18,15



Plastic  
Cube

Free  
Gratuit  
Gratis



BLACK PHOSPHATED - PHOSPHATÉ - FOSFATADO

CODE CÓDIGO	SIZE / MESURE MEDIDA	+	CAPACIDAD CAPACITY / CAPACITÉ	PRICE	€ / 1 PC
TPLN35025BP	3,5 x 25	PH2	0,60	4.000	59,45
TPLN35035BP	3,5 x 35	PH2	0,60	3.000	57,10

ASK FOR TECHNICAL INFORMATION / DEMANDEZ INFORMATIONS TECHNIQUES / SOLICITENOS LA FICHA TÉCNICA / SOLICITE A FICHA TÉCNICA PARA MAIS INFORMAÇÕES

## DRYWALL SELF DRILLING SCREW FOR PLASTERBOARD, BUGLE HEAD

VIS POUR PLAQUES DE PLÂTRE, AUTOPERCEUSE, TÊTE TROMPETTE

TORNILLO AUTOTALADRANTE PARA PLACAS DE CARTÓN-YESO, CABEZA TROMPETA

PARAFUSO AUTOPERFORANTE PLADUR PARA GESSO CARTONADO, CABEÇA DE EMBEBER

# TBPL



BLACK PHOSPHATED - PHOSPHATÉ - FOSFATADO

CODE CÓDIGO	SIZE / MESURE MEDIDA	+	CAPACIDAD CAPACITY / CAPACITÉ	PRICE	PRICE	€ / 100
TBPLN3525	3,5 x 25	PH2	3,00	1.000	12.000	1,19
TBPLN3535	3,5 x 35	PH2	3,00	1.000	6.000	1,54
TBPLN3545	3,5 x 45	PH2	3,00	500	6.000	1,96

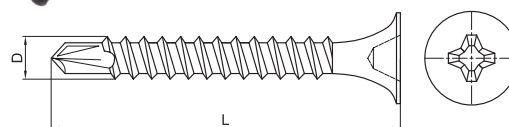

ASK FOR TECHNICAL INFORMATION / DEMANDEZ INFORMATIONS TECHNIQUES / SOLICITENOS LA FICHA TÉCNICA / SOLICITE A FICHA TÉCNICA PARA MAIS INFORMAÇÕES

## DRYWALL SELF DRILLING SCREW FOR PLASTERBOARD, COARSE THREAD, BUGLE HEAD

VIS POUR PLAQUES DE PLÂTRE, TÊTE TROMPETTE, POINTE CLOU, FILET SPÉCIAL

TORNILLO PARA PLACAS DE CARTÓN-YESO, ROSCA PASO ANCHO, CABEZA TROMPETA

PARAFUSO PLADUR PARA GESSO CARTONADO, CABEÇA DE EMBEBER

# TPRA



BLACK PHOSPHATED - PHOSPHATÉ - FOSFATADO



CODE CÓDIGO	SIZE / MESURE MEDIDA	+	PRICE	PRICE	€ / 100
TPRA39025	3,9 x 25	PH2	1.000	12.000	1,01
TPRA39035	3,9 x 35	PH2	1.000	6.000	1,33
TPRA39045	3,9 x 45	PH2	500	3.000	1,68
TPRA39055	3,9 x 55	PH2	500	3.000	2,06
TPRA48035	4,8 x 35	PH2	1.000	6.000	2,06



ASK FOR TECHNICAL INFORMATION / DEMANDEZ INFORMATIONS TECHNIQUES / SOLICITENOS LA FICHA TÉCNICA / SOLICITE A FICHA TÉCNICA PARA MAIS INFORMAÇÕES

**TBH** MAGNETIC HEXAGONAL NUT SETTER  
PORTE-EMBOUT HEXAG. MAGNÉTIQUE  
BOCAS HEXAGONALES MAGNÉTICAS  
BIT CHAVE DE CAIXA MAGNÉTICA, SEXTAVADO



CODE CÓ-DIGO	SIZE / MESURE MEDIDA				€ / 100
TBH006	1/4" - 6 mm	6	5	240	571,00
TBH007	1/4" - 7 mm	7	5	240	571,00
TBH008	1/4" - 8 mm	8	5	240	571,00
TBH010	1/4" - 10 mm	10	5	240	571,00

**TPPM** 1/4" MAGNETIC BIT HOLDER  
PORTE-EMBOUT MAGNÉTIQUE 1/4"  
PORTA PUNTAS MAGNÉTICO 1/4"  
PORTA BITS MAGNÉTICO 1/4"

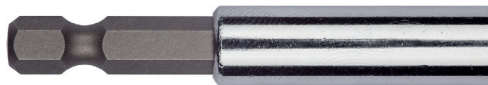



CODE CÓ-DIGO	SIZE / MESURE MEDIDA				€ / 100
TPPM014	1/4" x 60	1/4"	5	240	571,00

**TPU**

BITS POZIDRIV - PHILLIPS - TX  
EMBOUTS POZIDRIV - PHILLIPS - TX  
PUNTAS DE ATORNILLAR, POZIDRIV - PHILLIPS - TX  
BITS POZIDRIVE - PHILLIPS - TX





PHILLIPS

CODE CÓ-DIGO	SIZE / MESURE MEDIDA				€ / 100
TPUPHC01	Nº 1 / 25	PH1	25	1.200	83,70
TPUPHC02	Nº 2 / 25	PH2	25	1.200	83,70
TPUPHC03	Nº 3 / 25	PH3	25	1.200	83,70





PHILLIPS

CODE CÓ-DIGO	SIZE / MESURE MEDIDA				€ / 100
TPUPHL01	Nº 1 / 50	PH1	25	1.200	119,00
TPUPHL02	Nº 2 / 50	PH2	25	1.200	119,00
TPUPHL03	Nº 3 / 50	PH3	25	1.200	119,00





POZIDRIV

CODE CÓ-DIGO	SIZE / MESURE MEDIDA				€ / 100
TPUPOC01	Nº 1 / 25	PZ1	25	1.200	83,70
TPUPOC02	Nº 2 / 25	PZ2	25	1.200	83,70
TPUPOC03	Nº 3 / 25	PZ3	25	1.200	83,70





POZIDRIV

CODE CÓ-DIGO	SIZE / MESURE MEDIDA				€ / 100
TPUPOL01	Nº 1 / 50	PZ1	25	1.200	119,00
TPUPOL02	Nº 2 / 50	PZ2	25	1.200	119,00
TPUPOL03	Nº 3 / 50	PZ3	25	1.200	119,00





TX

CODE CÓ-DIGO	SIZE / MESURE MEDIDA				€ / 100
TPUTOC08	Nº 8 / 25	TX8	25	1.200	83,70
TPUTOC10	Nº 10 / 25	TX10	25	1.200	83,70
TPUTOC15	Nº 15 / 25	TX15	25	1.200	83,70
TPUTOC20	Nº 20 / 25	TX20	25	1.200	83,70



TX

CODE CÓ-DIGO	SIZE / MESURE MEDIDA				€ / 100
TPUTOC25	Nº 25 / 25	TX25	25	1.200	83,70
TPUTOC27	Nº 27 / 25	TX27	25	1.200	83,70
TPUTOC30	Nº 30 / 25	TX30	25	1.200	83,70
TPUTOC40	Nº 40 / 25	TX40	25	1.200	83,70

SELF-ADHESIVE PVC SCREW COVERS Ø 13

CACHE-VIS EN PVC ADHÉSIFS Ø 13

TAPA-TORNILLO DE PVC, ADHESIVO Ø 13

TAMPAS DE PVC ADESIVAS Ø 13

**TTC**



WHITE



BLACK



ANTHRACITE



GREY



GREY METAL



GRIS METAL RUGOSO



BEIGE



PINE



BEECH



OAK



CHERRY

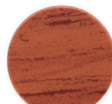

SAPELLY



WALNUT



TEXTIL FLAX-0





TEXTIL FLAX-1



TEXTIL FLAX-3

CODE CÓ-DIGO	COLOR / COLOUR / COULEUR			€ / 100
TTCBL	BLANCO / WHITE / BLANC	1.000	24.000	3,47
TTCNE	NEGRO / BLACK / NOIR	1.000	24.000	3,47
TTCGR	GRIS / GREY / GRIS	1.000	24.000	3,47
TTCGM	GRIS METAL / GREY METAL	1.000	24.000	3,47
TTCBE	BEIGE	1.000	24.000	3,47
TTCPI	PINO PINE / PIN	1.000	24.000	3,47
TTCHA	HAYA / BEECH / HETRE	1.000	24.000	3,47
TTCRO	ROBLE / OAK / CHÊNE	1.000	24.000	3,47

CODE CÓ-DIGO	COLOR / COLOUR / COULEUR			€ / 100
TTCCE	CEREZO CHERRY / CERISIER	1.000	24.000	3,47
TTCSA	SAPELLY	1.000	24.000	3,47
TTCNO	NOGAL / WALNUT / NOYER	1.000	24.000	3,47
TTCL0	TEXTIL LINO-0 / TEXTIL FLAX-0	1.000	24.000	3,47
TTCL1	TEXTIL LINO-1 / TEXTIL FLAX-1	1.000	24.000	3,47
TTCL2	TEXTIL LINO-3 / TEXTIL FLAX-3	1.000	24.000	3,47
TTCGMR	GRIS METAL RUGOSO	1.000	24.000	3,47
TTCANT	ANTRACITA / ANTHRACITE	1.000	24.000	3,47



European Import Group

# ANCHORS FOR WOOD RACCORDS POUR BOIS CONECTORES PARA MADERA FERRAGENS PARA CONSTRUÇÕES EM MADEIRA

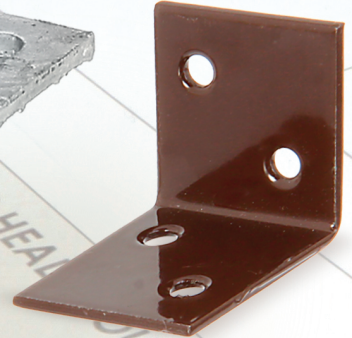
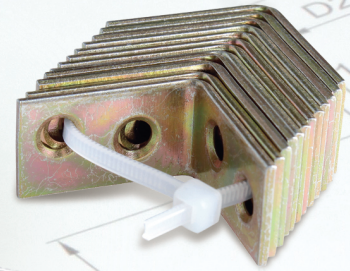
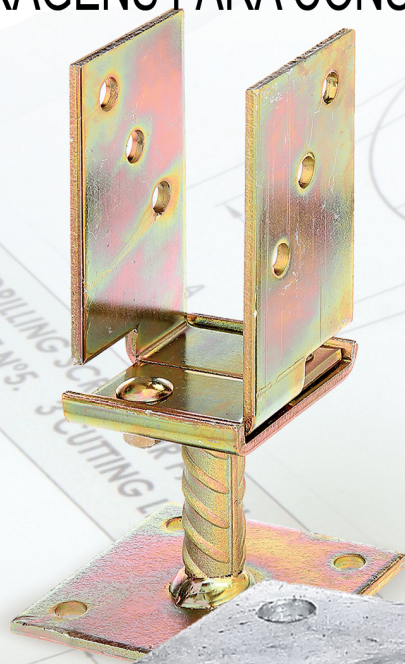

## MATERIALS / MATÉRIAUX / MATERIALES / MATERIAIS:



LIGHTWEIGHT CONCRET  
BÉTON LÉGER  
HORMIGÓN LIGERO  
BETÃO LEVE



CONCRETE  
BÉTON  
HORMIGÓN  
BETÃO



HOLLOW CONCRETE BLOCK  
BLOC DE BÉTON CREUX  
BLOQUE HUECO HORMIGÓN  
BLOCO DE BETÃO OCO



SOLID BRICK  
BRIQUE PLEINE  
LADRILLO MACIZO  
TIJOLO MACIÇO



STONE  
PIERRE  
PIEDRA  
PEDRA

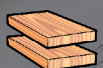

THIN WOOD  
BOIS MINCE  
MADERA FINA  
MADEIRA FINA



PINE WOOD  
BOIS PIN  
MADERA PINO  
MADEIRA PINHO



NOBLE WOOD  
BOIS NOBLE  
MADERA NOBLE  
MADEIRA NOBRE



### PYRAMIDAL SQUARED POST HOLDER, HOT DIP GALVANIZED

ANCRE À ENFORCER POUR POTEAU BOIS, GALVANISÉE À CHAUD  
 ANCLAJE CUADRADO PUNTA PIRAMIDAL PARA ENTERRAR, GALVANIZADO EN CALIENTE  
 ANCORAGEM QUADRADO, COM PONTA PIRAMIDAL PARA ENTERRAR, GALVANIZADO A QUENTE

CODE CÓDIGO	SIZES / DIMENSIONS / MEDIDAS a x b x c x d		Nº AGUJEROS Nº HOLE / TROUS		€ / 100
CM0001	71 x 71 x 150 x 750	1,80	4 x Ø11	1	1.312,66

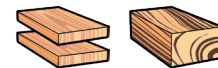
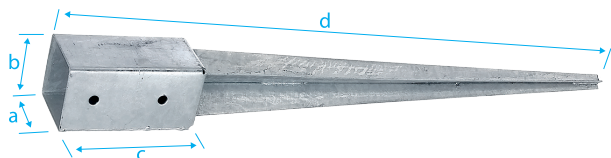

HOT DIP GALVANIZED  
 GALVANISÉE À CHAUD  
 GALVANIZADA EN CALIENTE  
 GALVANIZADO A QUENTE

### SQUARED POST HOLDER, HOT DIP GALVANIZED

ANCRE SUR PLATINE POUR POTEAU BOIS, GALVANISÉE À CHAUD  
 BASE CUADRADA PARA POSTE DE MADERA, GALVANIZADA EN CALIENTE  
 BASE QUADRADA PARA POSTE DE MADEIRA, GALVANIZADO A QUENTE

CODE CÓDIGO	MEDIDAS / SIZES / DIMENSIONS a x b x c x d x e		Nº AGUJEROS Nº HOLE / TROUS		€ / 100
CM0010	71 x 71 x 150 x 150 x 150	1,80	4 x Ø11	1	976,66

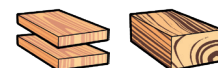
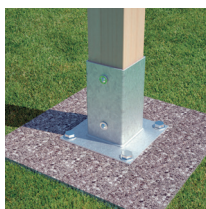
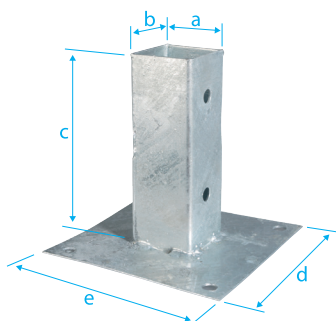

HOT DIP GALVANIZED  
 GALVANISÉE À CHAUD  
 GALVANIZADA EN CALIENTE  
 GALVANIZADO A QUENTE

### ANCHOR POST, L-SHAPED, WITH WELDED CORRUGATED STEEL BAR Ø 19 , HOT DIP GALVANIZED

ANCRE DE POTEAU, FORME "L", AVEC TIGE À SCELLER EN ACIER CANNELÉ Ø 19, SOUDÉE, GALVANISÉE À CHAUD  
 ANCLAJE EN FORMA DE "L", CON BARRA DE ACERO CORRUGADO Ø 19 SOLDADA, GALVANIZADO EN CALIENTE  
 ANCORAGEM EM FORMA DE "L", COM BARRA DE FERRO NERVURADO Ø 19 SOLDADO, GALVANIZADO A QUENTE

CODE CÓDIGO	MEDIDAS / SIZES / DIMENSIONS a x b x c x d		Nº AGUJEROS Nº HOLE / TROUS		€ / 100
CM0020	80 x 100 x 200 x 60	4,00	3 x Ø11	1	1.019,15

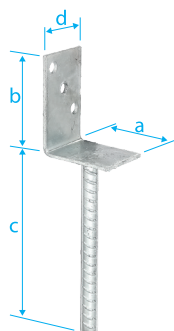

CARGA ADMISIBLE "F"  
 MAX. LOAD  
 CHARGEMENT MAX.  
 14,0 kN

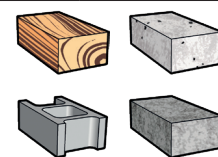

HOT DIP GALVANIZED  
 GALVANISÉE À CHAUD  
 GALVANIZADA EN CALIENTE  
 GALVANIZADO A QUENTE

### ANCHOR POST, U-SHAPED, WITH WELDED CORRUGATED STEEL BAR Ø 19 , HOT DIP GALVANIZED

ANCRE DE POTEAU, FORME "U", AVEC TIGE À SCELLER EN ACIER CANNELÉ Ø 19, SOUDÉE, GALVANISÉE À CHAUD  
 ANCLAJE EN FORMA DE "U", CON BARRA DE ACERO CORRUGADO Ø 19 SOLDADA, GALVANIZADO EN CALIENTE  
 ANCORAGEM EM FORMA DE "U", COM BARRA DE FERRO NERVURADO Ø 19 SOLDADO, GALVANIZADO A QUENTE

CODE CÓDIGO	MEDIDAS / SIZES / DIMENSIONS a x b x c x d		Nº AGUJEROS Nº HOLE / TROUS		€ / 100
CM0030	71 x 100 x 200 x 60	4,00	6 x Ø11	1	1.287,58
CM0035	91 x 100 x 200 x 60	4,00	6 x Ø11	1	1.318,69
CM0040	101 x 100 x 200 x 60	4,00	6 x Ø11	1	1.365,85

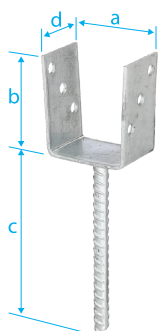

CARGA ADMISIBLE "F"  
 MAX. LOAD  
 CHARGEMENT MAX.  
 19,5 kN

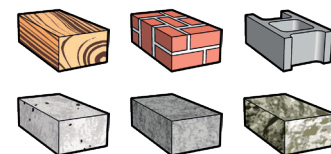
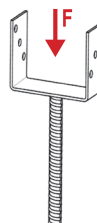

HOT DIP GALVANIZED  
 GALVANISÉE À CHAUD  
 GALVANIZADA EN CALIENTE  
 GALVANIZADO A QUENTE

# TIMBER CONNECTORS

RACCORDS POUR BOIS / CONECTORES PARA MADERA / FERRAGENS PARA CONSTRUÇÕES EM MADEIRA

**ANCHOR POST, U-SHAPED, TO BE SCREWED DIRECTLY, HOT DIP GALVANIZED**  
 ANCRE DE POTEAU, FORME "U", À CHEVILLER, GALVANISÉE À CHAUD  
 ANCLAJE EN FORMA DE "U", PARA ATORNILLAR DIRECTAMENTE, GALVANIZADO EN CALIENTE  
 ANCORAGEM EM FORMA DE "U", PARA APARAFUSAR DIRECTAMENTE, GALVANIZADO A QUENTE

CODE CÓDIGO	MEDIDAS / SIZES / DIMENSIONS a x b x c x d x e		Nº AGUJEROS Nº HOLE / TROUS		€ / 100
CM0050	71 x 200 x 60 x 50 x 200	5,00	6 x ø11	1	<b>1.447,53</b>
CM0055	91 x 200 x 60 x 50 x 200	5,00	6 x ø11	1	<b>1.499,47</b>
CM0060	101 x 200 x 60 x 50 x 200	5,00	6 x ø11	1	<b>1.544,83</b>

HOT DIP GALVANIZED  
GALVANISÉE À CHAUD  
GALVANIZADA EN CALIENTE  
GALVANIZADO A QUENTE

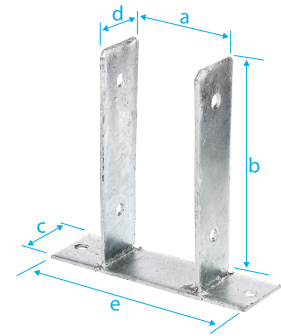
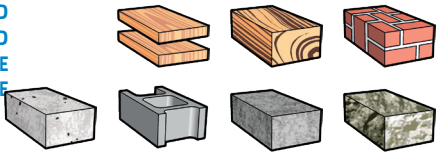

**SYMMETRICAL SUPPORT POST BASE, HOT DIP GALVANIZED**  
 SUPPORT DE POTEAU, ÉGAL, GALVANISÉE À CHAUD  
 SOPORTE PARA POSTE, SIMÉTRICO, GALVANIZADO EN CALIENTE  
 SUPORTE PARA POSTE, SIMÉTRICO, GALVANIZADO A QUENTE

CODE CÓDIGO	MEDIDAS / SIZES / DIMENSIONS a x b x c x d x e		Nº AGUJEROS Nº HOLE / TROUS		€ / 100
CM0070	70 x 90 x 70 x 80 x 90	5,00	8 x ø11	1	<b>1.404,12</b>
CM0075	100 x 100 x 100 x 100 x 100	5,00	8 x ø11	1	<b>2.151,24</b>

HOT DIP GALVANIZED  
GALVANISÉE À CHAUD  
GALVANIZADA EN CALIENTE  
GALVANIZADO A QUENTE

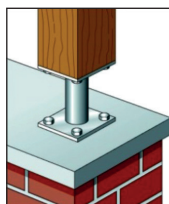
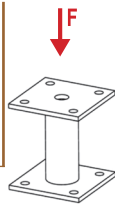
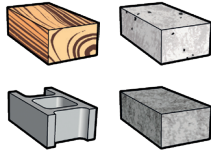

CARGA ADMISIBLE "F"  
MAX. LOAD  
CHARGEMENT MAX.  
24,5 kN

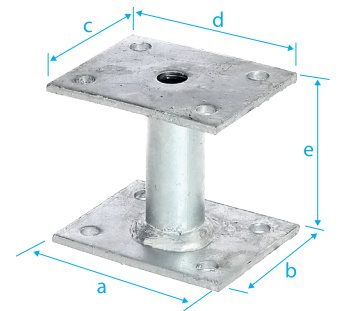

**ASYMMETRIC SUPPORT POST BASE, HOT DIP GALVANIZED**  
 SUPPORT DE POTEAU, INÉGAL, GALVANISÉE À CHAUD  
 SOPORTE PARA POSTE, ASIMÉTRICO, GALVANIZADO EN CALIENTE  
 SUPORTE PARA POSTE, ASIMÉTRICO, GALVANIZADO A QUENTE

CODE CÓDIGO	MEDIDAS / SIZES / DIMENSIONS a x b x c x d x e		Nº AGUJEROS Nº HOLE / TROUS		€ / 100
CM0080	150 x 150 x 100 x 100 x 100	4,00	8 x ø11	1	<b>2.002,41</b>

HOT DIP GALVANIZED  
GALVANISÉE À CHAUD  
GALVANIZADA EN CALIENTE  
GALVANIZADO A QUENTE

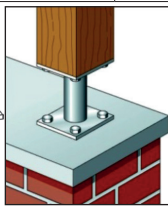
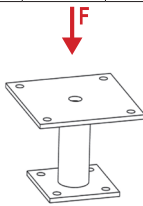
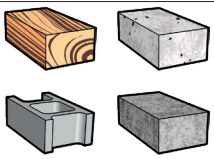

CARGA ADMISIBLE "F"  
MAX. LOAD  
CHARGEMENT MAX.  
24,5 kN

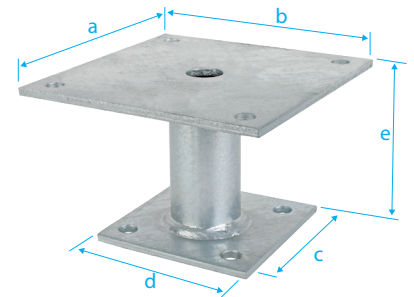

**ANCHOR POST, HEIGHT ADJUSTABLE (30-150 MM), M20 BOLT, YELLOW ZINC PLATED**  
 ANCRE DE POTEAU, HAUTEUR RÉGLABLE VARIABLE (30-150 MM), AVEC UNE VIS M20, BICHROMATÉE  
 ANCLAJE PARA POSTE, ALTURA REGULABLE (30-150 MM), ESPÁRRAGO M20, BICROMATADO  
 ANCORAGEM PARA POSTE, COM ALTURA REGULÁVEL (30-150 MM), PERNO M 20, PASSIVADO AMARELO

CODE CÓDIGO	MEDIDAS / SIZES / DIMENSIONS a x b x c x d x e		Nº AGUJEROS Nº HOLE / TROUS		€ / 100
CM0090	70 x 70 x 100 x 100 x 150	5,00	8 x ø11	1	<b>2.152,58</b>
CM0095	150 x 150 x 100 x 100 x 150	5,00	8 x ø11	1	<b>2.602,23</b>

HOT DIP GALVANIZED  
GALVANISÉE À CHAUD  
GALVANIZADA EN CALIENTE  
GALVANIZADO A QUENTE

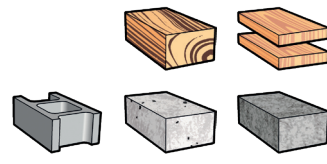

CARGA ADMISIBLE "F"  
MAX. LOAD  
CHARGEMENT MAX.  
18,5 kN

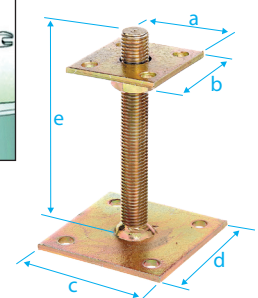
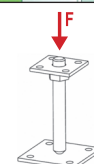
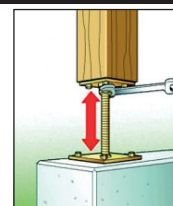

### ANCHOR POST, U-SHAPED, ADJUSTABLE WIDTH, YELLOW ZINC PLATED

ANCRE DE POTEAU, FORME "U", LARGEUR RÉGLABLE, GALVANISÉE BICHROMATÉE  
 ANCLAJE PARA POSTE EN FORMA DE "U", ANCHO REGULABLE, BICROMATADO  
 ANCORAGEM PARA POSTE EM FORMA DE "U", LARGURA REGULÁVEL, PASSIVADO AMARELO

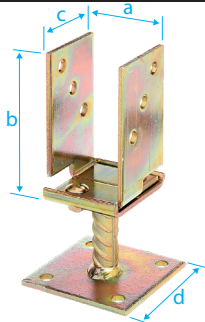

CODE CÓDIGO	MEDIDAS / SIZES / DIMENSIONS a x b x c x d		Nº AGUJEROS Nº HOLE / TROUS		€ / 100
CM0100	71-131 x 110 x 70 x 100	5,00	10 x ø11	1	2.387,84

CARGA ADMISIBLE "F"  
MAX. LOAD  
CHARGEMENT MAX.  
18,5 kN

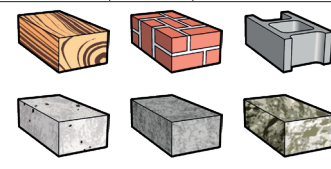
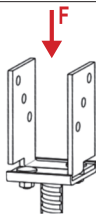

### ANCHOR POST, U-SHAPED, ADJUSTABLE WIDTH, CORRUGATED STEEL BAR ø 19, YELLOW ZINC PLATED

ANCRE DE POTEAU, FORME "U", LARGEUR RÉGLABLE, AVEC TIGE À BÉTONNER ø 19, GALVANISÉE BICHROMATÉE  
 ANCLAJE PARA POSTE EN FORMA DE "U", ANCHO REGULABLE, BARRA ACERO CORRUGADO ø 19, BICROMATADO  
 ANCORAGEM PARA POSTE EM FORMA DE "U", LARGURA REGULÁVEL, COM BARRA DE FERRO NERVURADO ø 19, PASS. AMARELO

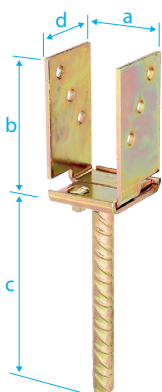

CODE CÓDIGO	MEDIDAS / SIZES / DIMENSIONS a x b x c x d		Nº AGUJEROS Nº HOLE / TROUS		€ / 100
CM0110	71-131 x 110 x 200 x 70	5,00	6 x ø11	1	2.344,21

CARGA ADMISIBLE "F"  
MAX. LOAD  
CHARGEMENT MAX.  
18,5 kN

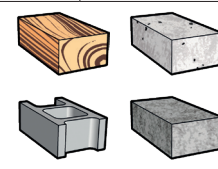
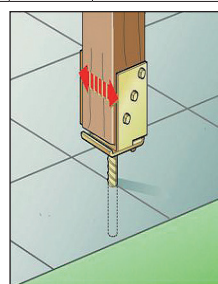
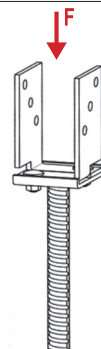

### L-SHAPED WITH WELDED SCREW 9 x 45 MM, FOR FENCE PANELS, YELLOW ZINC PLATED

ÉQUERRE FORME "L" POUR CLÔTURES TRESSÉES, AVEC VIS À BOIS SOUDÉE 9 x 45 MM, BICHROMATÉE  
 ESCUADRA EN FORMA DE "L", PARA CELOSÍAS CON TORNILLO ROSCA MADERA 9 x 45 MM SOLDADO, BICROMATADA  
 ESQUADRO EM "L" PARA CERCAS COM PARAFUSO ROSCA MADEIRA 9x45MM, SOLDADO, PASS. AMARELO

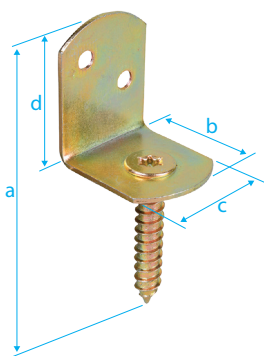

CODE CÓDIGO	MEDIDAS / SIZES / DIMENSIONS a x b x c x d		Nº AGUJEROS Nº HOLE / TROUS		€ / 100
CM0120	83 x 32 x 30 x 38	2,00	2 x ø5,0	50	87,85

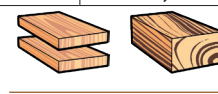
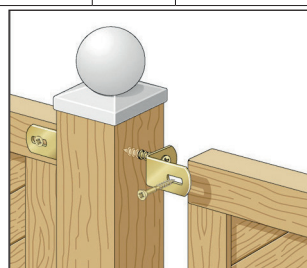

### SENDZIMIR GALVANIZED FLAT PLATE

PLATINE D'ASSEMBLAGE GALVANISÉE SENDZIMIR  
 PLETINA DE ENSAMBLAJE GALVANIZADA SENDZIMIR  
 CHAPA DE UNIÃO GALVANIZADA SENDZIMIR



CODE CÓDIGO	a	b		Nº AGUJEROS Nº HOLE / TROUS	Nº AGUJEROS Nº HOLE / TROUS		€ / 100
CM0130	100	35	2,50	2 / 12	11 / 4,5	50	72,68
CM0135	135	55	2,50	2 / 14	11 / 5	50	175,02

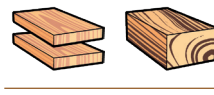



HOT DIP GALVANIZED  
GALVANISÉE À CHAUD  
GALVANIZADA EN CALIENTE  
GALVANIZADO A QUENTE

# TIMBER CONNECTORS

RACCORDS POUR BOIS / CONECTORES PARA MADERA / FERRAGENS PARA CONSTRUÇÕES EM MADEIRA

ANGLED BRACKET, SENDZIMIR GALVANIZED  
ÉQUERRE D'ASSEMBLAGE, GALVANISÉE SENDZIMIR  
ESCUADRA DE ENSAMBLAJE, GALVANIZADA SENDZIMIR  
ESQUADRO DE LIGAÇÃO, GALVANIZADO SENDZIMIR

CODE CÓDIGO	MEDIDAS / SIZES / DIMENSIONS a x b x c		Nº AGUJEROS Nº HOLE / TROUS		€ / 100
CM0145	40 x 40 x 20	2,00	6 / ø 4,5	100	<b>38,17</b>
CM0150	40 x 40 x 40	2,00	8 / ø 4,5	50	<b>62,53</b>
CM0155	40 x 40 x 60	2,50	12 / ø 5,0	50	<b>99,95</b>
CM0160	50 x 50 x 40	2,00	8 / ø 4,5	50	<b>71,82</b>
CM0165	60 x 60 x 40	2,50	12 / ø 4,5	50	<b>101,06</b>
CM0170	60 x 60 x 60	2,50	16 / ø 4,5	50	<b>130,62</b>
CM0175	60 x 60 x 80	2,50	20 / ø 4,5	25	<b>218,68</b>
CM0180	80 x 80 x 40	2,00	12 / ø 5,0	50	<b>126,72</b>
CM0185	80 x 80 x 80	2,50	28 / ø 4,5	25	<b>263,18</b>
CM0190	100 x 100 x 40	2,00	15 / ø 5,0	50	<b>160,78</b>
CM0195	100 x 100 x 100	2,50	40 / ø 4,5	25	<b>414,02</b>

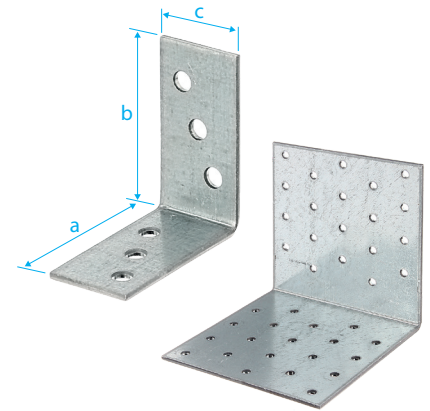

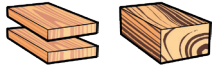

ASK FOR TECHNICAL INFORMATION / DEMANDEZ INFORMATIONS TECHNIQUES / SOLICITENOS LA FICHA TÉCNICA / SOLICITE A FICHA TÉCNICA PARA MAIS INFORMAÇÕES



SENDZIMIR GALVANIZED  
GALVANISÉE SENDZIMIR  
GALVANIZADO SENDZIMIR



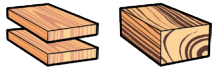
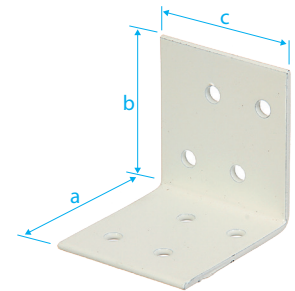

ANGLED BRACKET, SENDZIMIR GALVANIZED AND WHITE POWDER COATED  
ÉQUERRE D'ASSEMBLAGE, GALVANISÉE SENDZIMIR + PLASTIFIÉE BLANC  
ESCUADRA DE ENSAMBLAJE, GALVANIZADA Y PLASTIFICADA BLANCA  
ESQUADRO DE LIGAÇÃO, GALVANIZADO E PLASTIFICADO A BRANCO

CODE CÓDIGO	MEDIDAS / SIZES / DIMENSIONS a x b x c		Nº AGUJEROS Nº HOLE / TROUS		€ / 100
CM0200	40 x 40 x 40	2,00	8 / ø 4,5	50	<b>116,19</b>
CM0205	50 x 50 x 40	2,00	8 / ø 4,5	50	<b>126,37</b>
CM0210	60 x 60 x 40	2,50	12 / ø 4,5	50	<b>174,12</b>
CM0215	60 x 60 x 60	2,50	16 / ø 4,5	50	<b>224,88</b>



ANGLED BRACKET, WITH SAME WINGS, SENDZIMIR GALVANIZED  
ÉQUERRE D'ASSEMBLAGE, ÉGALE, GALVANISÉE SENDZIMIR  
ESCUADRA DE ENSAMBLAJE, CON LADOS IGUALES, GALVANIZADA SENDZIMIR  
ESQUADRO DE LIGAÇÃO, COM DOIS LADOS IGUAIS, GALVANIZADO SENDZIMIR

CODE CÓDIGO	MEDIDAS / SIZES / DIMENSIONS a x b x c		Nº AGUJEROS Nº HOLE / TROUS		€ / 100
CM0220	50 x 50 x 35	2,50	2/11,0 - 12/3,5	50	<b>68,16</b>
CM0225	60 x 60 x 45	2,50	2/11,0 - 12/4,5	50	<b>113,45</b>
CM0230	70 x 70 x 55	2,50	2/11,0 - 16/4,5	50	<b>140,84</b>
CM0235	90 x 90 x 40	3,00	4/11,0 - 16/4,5	50	<b>159,53</b>
CM0240	90 x 90 x 65	2,50	2/12,0-12/7,5-16/4,5	25	<b>175,73</b>
CM0245	100 x 100 x 90	3,00	2/14,0 - 28/7,5	25	<b>358,18</b>

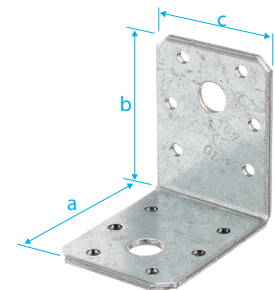



ASK FOR TECHNICAL INFORMATION / DEMANDEZ INFORMATIONS TECHNIQUES / SOLICITENOS LA FICHA TÉCNICA / SOLICITE A FICHA TÉCNICA PARA MAIS INFORMAÇÕES



SENDZIMIR GALVANIZED  
GALVANISÉE SENDZIMIR  
GALVANIZADO SENDZIMIR



ANGLED BRACKET, WITH DIFFERENT WINGS, SENDZIMIR GALVANIZED  
ÉQUERRE D'ASSEMBLAGE, INÉGALE, GALVANISÉE SENDZIMIR  
ESCUADRA DE ENSAMBLAJE, CON LADOS DESIGUALES, GALVANIZADA SENDZIMIR  
ESQUADRO DE LIGAÇÃO, COM LADOS DIFERENTES, GALVANIZADO SENDZIMIR

CODE CÓDIGO	MEDIDAS / SIZES / DIMENSIONS a x b x c		Nº AGUJEROS Nº HOLE / TROUS		€ / 100
CM0250	40 x 60 x 60	2,50	2/11,0 - 13/5,0	50	<b>149,91</b>
CM0255	60 x 80 x 60	2,50	3/11,0 - 18/5,0	50	<b>201,01</b>

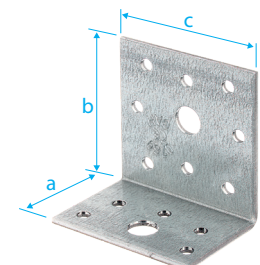

SENDZIMIR GALVANIZED  
GALVANISÉE SENDZIMIR  
GALVANIZADO SENDZIMIR



### LARGE CORNER, SENDZIMIR GALVANIZED

ÉQUERRE D'ANGLE LARGE, GALVANISÉE SENDZIMIR  
 ESCUADRA GRANDE DE ÁNGULO, GALVANIZADA SENDZIMIR  
 ESQUADRO LARGO ANGULAR, GALVANIZADO SENDZIMIR

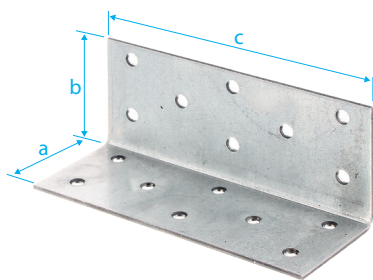

CODE CÓDIGO	MEDIDAS / SIZES / DIMENSIONS a x b x c		Nº AGUJEROS Nº HOLE / TROUS		€ / 100
CM0260	40 x 40 x 100	2,00	16 / 4,5	25	161,72



SENDZIMIR GALVANIZED  
 GALVANISÉE SENDZIMIR  
 GALVANIZADO SENDZIMIR

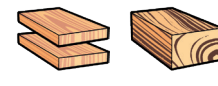

### ANGLED BRACKET REINFORCED, SENDZIMIR GALVANIZED

ÉQUERRE RENFORCÉE, GALVANISÉE SENDZIMIR  
 ESCUADRA REFORZADA, GALVANIZADA SENDZIMIR  
 ESQUADRO REFORÇADO, GALVANIZADO SENDZIMIR

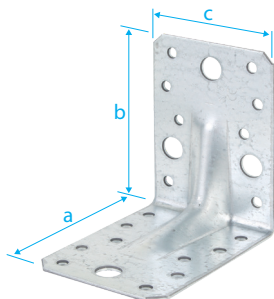

CODE CÓDIGO	MEDIDAS / SIZES / DIMENSIONS a x b x c		Nº AGUJEROS Nº HOLE / TROUS		€ / 100
CM0270	70 x 70 x 55	2,50	2/11,0 - 16/4,5	50	145,39
CM0275	90 x 90 x 65	2,50	2/11,0-12/7,5-16/4,5	25	175,22
CM0280	100 x 100 x 90	3,00	2/14,0 - 36/4,5	20	342,59

CODE CÓDIGO	FUERZA MAX. "Fx" MAX. PRESSURE / FORZE MAX.	FUERZA MAX. "Fz" MAX. PRESSURE / FORZE MAX.
CM0270	2,30 kN	2,00 kN
CM0275	3,10 kN	2,80 kN
CM0280	3,80 kN	3,50 kN

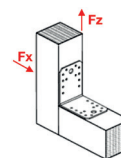

SENDZIMIR GALVANIZED  
 GALVANISÉE SENDZIMIR  
 GALVANIZADO SENDZIMIR

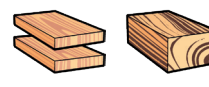

### ANGLED BRACKET ADJUSTABLE, SENDZIMIR GALVANIZED

ÉQUERRE RÉGLABLE, GALVANISÉE SENDZIMIR  
 ESCUADRA REGULABLE, GALVANIZADA SENDZIMIR  
 ESQUADRO REGULÁVEL, GALVANIZADO SENDZIMIR

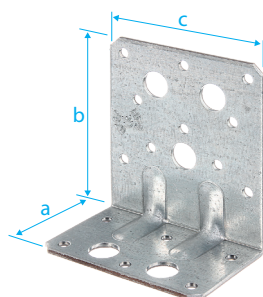

CODE CÓDIGO	MEDIDAS / SIZES / DIMENSIONS a x b x c		Nº AGUJEROS Nº HOLE / TROUS		€ / 100
CM0310	90 x 50 x 50	2,50	3/13,0 - 10/5,0	50	154,45
CM0315	90 x 90 x 80	4,50	5/13,0 - 16/5,0	50	218,06

CODE CÓDIGO	FUERZA MAX. "Fx" MAX. PRESSURE / FORZE MAX.	FUERZA MAX. "Fz" MAX. PRESSURE / FORZE MAX.
CM0310	2,00 kN	1,50 kN
CM0315	2,50 kN	2,20 kN

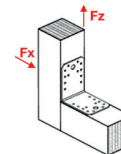

SENDZIMIR GALVANIZED  
 GALVANISÉE SENDZIMIR  
 GALVANIZADO SENDZIMIR



### ANGLED BRACKET ADJUSTABLE, SENDZIMIR GALVANIZED

ÉQUERRE RÉGLABLE, GALVANISÉE SENDZIMIR  
 ESCUADRA REGULABLE, GALVANIZADA SENDZIMIR  
 ESQUADRO REGULÁVEL, GALVANIZADO SENDZIMIR

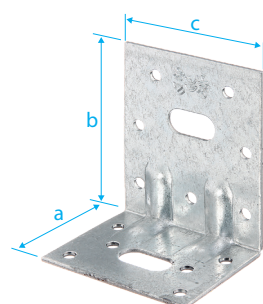

CODE CÓDIGO	MEDIDAS / SIZES / DIMENSIONS a x b x c		Nº AGUJEROS Nº HOLE / TROUS		€ / 100
CM0330	77 x 64 x 50	2,00	13 / 5,0	50	155,26

FUERZA MAX. "Fx" MAX. PRESSURE / FORZE MAX.	FUERZA MAX. "Fz" MAX. PRESSURE / FORZE MAX.
2,20 kN	2,00 kN

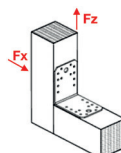

SENDZIMIR GALVANIZED  
 GALVANISÉE SENDZIMIR  
 GALVANIZADO SENDZIMIR



# TIMBER CONNECTORS

RACCORDS POUR BOIS / CONECTORES PARA MADERA / FERRAGENS PARA CONSTRUÇÕES EM MADEIRA

## ANGLED BRACKET REINFORCED, SENDZIMIR GALVANIZED

ÉQUERRE RENFORCÉE, GALVANISÉE SENDZIMIR  
ESCUADRA REFORZADA, GALVANIZADA SENDZIMIR  
ESQUADRO REFORÇADO, GALVANIZADO SENDZIMIR

CODE CÓDIGO	SIZES / DIMENSIONS / MEDIDAS a x b x c		Nº AGUJEROS Nº HOLE / TROUS		€ / 100
CM0350	150 x 150 x 65	2,50	3/11,0 - 28/5,0	25	<b>350,80</b>

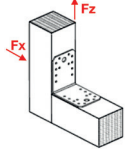

FUERZA MAX. "Fx"  
MAX. PRESSURE / FORZE MAX.  
4,20 kN

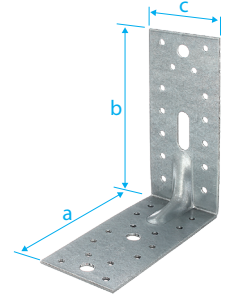

FUERZA MAX. "Fz"  
MAX. PRESSURE / FORZE MAX.  
3,80 kN

SENDZIMIR GALVANIZED  
GALVANISÉE SENDZIMIR  
GALVANIZADO SENDZIMIR



## ASYMMETRIC RAFTER PURLIN ANCHOR, SENDZIMIR GALVANIZED, RIGHT OR LEFT

ÉQUERRE RENVOYÉE, GALVANISÉE SENDZIMIR, DROITE OU GACHE  
ESCUADRA ASIMÉTRICA, GALVANIZADA SENDZIMIR, DERECHA O IZQUIERDA  
ESQUADRO ASIMÉTRICA, GALVANIZADO SENDZIMIR, DIREITA OU ESQUERDA

CODE CÓDIGO	SIZES / DIMENSIONS / MEDIDAS a x b x c		Nº AGUJEROS Nº HOLE / TROUS		€ / 100
CM0360	32 x 32 x 170 D/R/D →	2,00	20 / 5,0	25	<b>108,75</b>
CM0365	32 x 32 x 170 I/G/L ←	2,00	20 / 5,0	25	<b>108,75</b>

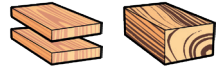

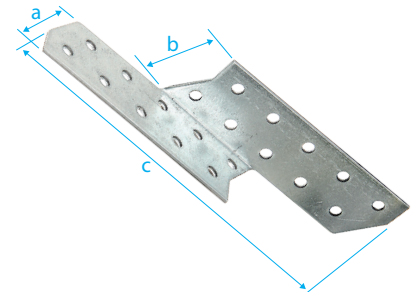

SENDZIMIR GALVANIZED  
GALVANISÉE SENDZIMIR  
GALVANIZADO SENDZIMIR



## PERFORATED SUPPORT, U-SHAPPED JOIST BEARING, SENDZIMIR GALVANIZED

SUPPORT EN "U", AVEC TROUS POUR SCELLEMENT, GALVANISÉE SENDZIMIR  
SOPORTE PERFORADO EN "U" CON ALAS EXTERIORES Y ORIFICIOS DE SELLADO, GALVANIZADO SENDZIMIR  
SUPORE PERFORADO EM "U" COM ALAS EXTERIORES E ORIFICIOS SELADOS, GALVANIZADO SENDZIMIR

CODE CÓDIGO	SIZES / DIMENSIONS / MEDIDAS a x b x c		Nº AGUJEROS Nº HOLE / TROUS		€ / 100
CM0370	40 x 110 x 110	2,00	4/9,0 - 22/5,0	25	<b>308,32</b>
CM0375	60 x 100 x 138	2,00	4/9,0 - 22/5,0	25	<b>294,79</b>
CM0380	70 x 125 x 140	2,00	4/13,0 - 26/5,0	25	<b>367,07</b>
CM0385	80 x 120 x 150	2,00	4/11,0 - 28/5,0	25	<b>339,95</b>
CM0390	100 x 140 x 170	2,00	4/11,0 - 34/5,0	25	<b>429,77</b>

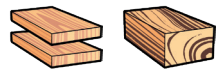

GALVANIZADO SENDZIMIR  
SENDZIMIR GALVANIZED  
GALVANISÉE SENDZIMIR

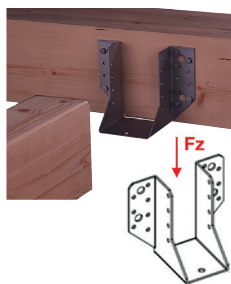

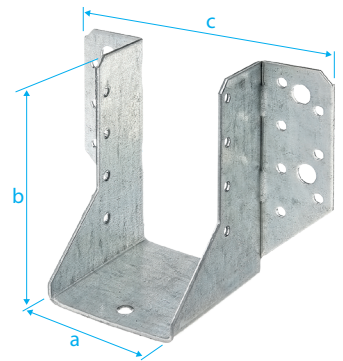

CODE CÓDIGO	FUERZA MAX. "Fz" MAX. PRESSURE / FORZE MAX.
CM0370	3,30 kN
CM0375	3,80 kN
CM0380	4,30 kN
CM0385	4,80 kN
CM0390	6,00 kN



## PERFORATED SUPPORT, U-SHAPPED ADJUSTABLE JOIST BEARING, SENDZIMIR GALVANIZED

SUPPORT EN "U", À ÉCARTEMENT VARIABLE GALVANISÉ, AVEC TROUS POUR SCELLEMENT, DROIT OU GAUCHE  
SOPORTE PERFORADO EN "U" CON ANCHO VARIABLE Y ORIFICIOS DE SELLADO, GALVANIZADO SENDZIMIR  
SUPORE PERFORADO EM "U" COM ALAS REGULÁVEIS E ORIFICIOS SELADOS, GALVANIZADO SENDZIMIR

CODE CÓDIGO	MEDIDAS / SIZES / DIMENSIONS a x b		Nº AGUJEROS Nº HOLE / TROUS		€ / 100
CM0400	25 x 140 D/R/D →	2,00	20 / 4,80	25	<b>237,58</b>
CM0405	25 x 140 I/G/L ←	2,00	20 / 4,80	25	<b>237,58</b>



SENDZIMIR GALVANIZED  
GALVANISÉE SENDZIMIR  
GALVANIZADO SENDZIMIR

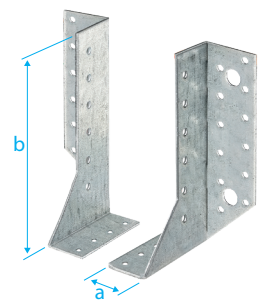
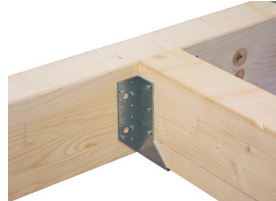

## PERFORATED PLATE SUPPORT, SENDZIMIR GALVANIZED

BANDE D'ASSEMBLAGE GALVANISÉE SENDZIMIR  
 PLETINA DE ENSAMBLAJE, GALVANIZADA SENDZIMIR  
 CHAPA DE MONTAGEM, GALVANIZADO SENDZIMIR



CODE CÓDIGO	SIZES / DIMENSIONS / MEDIDAS a x b		Nº AGUJEROS Nº HOLE / TROUS		€ / 100
CM0420	120 x 40	2,00	9 / 5,00	50	<b>80,03</b>
CM0425	160 x 40	2,00	12 / 5,00	50	<b>116,90</b>
CM0430	200 x 60	2,00	2/11,0 - 26/5,0	25	<b>181,28</b>
CM0435	240 x 60	2,00	2/11,0 - 32/4,5	25	<b>209,65</b>
CM0440	200 x 80	2,00	2/11,0 - 40/5,0	25	<b>231,15</b>
CM0445	240 x 80	2,00	2/11,0 - 48/5,0	25	<b>308,40</b>



SENDZIMIR GALVANIZED  
 GALVANISÉE SENDZIMIR  
 GALVANIZADO SENDZIMIR

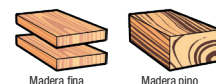

## ANGLED BRACKET FOR CONCRETE, SENDZIMIR GALVANIZED

ÈQUERRE À BÉTON GALVANISÉE SENDZIMIR  
 ESCUADRA PARA CEMENTO, GALVANIZADA SENDZIMIR  
 ESQUADRO PARA CIMENTO, GALVANIZADO SENDZIMIR

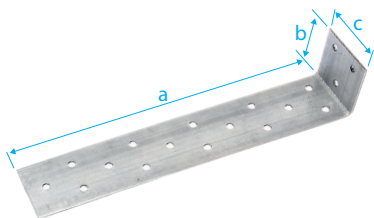

CODE CÓDIGO	SIZES / DIMENSIONS / MEDIDAS a x b x c		Nº AGUJEROS Nº HOLE / TROUS		€ / 100
CM0460	200 x 40 x 40	2,00	18 / 4,50	10	<b>173,02</b>

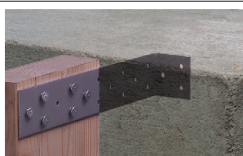

SENDZIMIR GALVANIZED  
 GALVANISÉE SENDZIMIR  
 GALVANIZADO SENDZIMIR

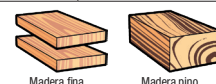

## FLAT CONNECTOR, SENDZIMIR GALVANIZED

PLATINE D'ASSEMBLAGE "T" GALVANISÉE SENDZIMIR  
 PLETINA DE ENSAMBLAJE "T", GALVANIZADA SENDZIMIR  
 CHAPA DE MONTAGEM EM "T", GALVANIZADO SENDZIMIR

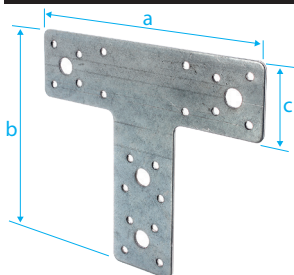

CODE CÓDIGO	SIZES / DIMENSIONS / MEDIDAS a x b x c		Nº AGUJEROS Nº HOLE / TROUS		€ / 100
CM0470	160 x 142 x 45	2,50	4/11,0 - 20/4,5	20	<b>724,11</b>



SENDZIMIR GALVANIZED  
 GALVANISÉE SENDZIMIR  
 GALVANIZADO SENDZIMIR

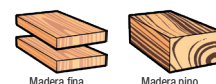

## PERFORATED BANDING, SENDZIMIR GALVANIZED

BANDE PERFORÉE GALVANISÉE SENDZIMIR  
 CINTA PERFORADA GALVANIZADA SENDZIMIR  
 FITA PERFURADA GALVANIZADA SENDZIMIR



CODE CÓDIGO	SIZES / DIMENSIONS / MEDIDAS a x b x c		Nº AGUJEROS Nº HOLE / TROUS		€ / 100
CM0480	20 x 12 x 3.000	1,00	7,00	5	<b>1.038,98</b>

SENDZIMIR GALVANIZED  
 GALVANISÉE SENDZIMIR  
 GALVANIZADO SENDZIMIR

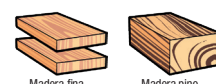

## ANCHOR NAILS, SENDZIMIR GALVANIZED

POINTES DE FIXATION GALVANISÉE SENDZIMIR  
 PUNTAS DE FIJACIÓN, GALVANIZADAS SENDZIMIR  
 PREGO DE FIXAÇÃO, GALVANIZADO SENDZIMIR

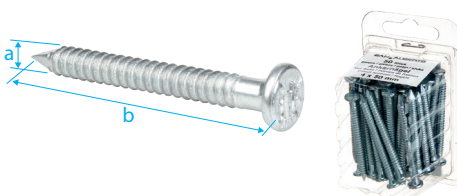

CODE CÓDIGO	MEDIDAS / SIZES / DIMENSIONS a x b				€ / 100
CM0490	4 x 40			50	<b>13,92</b>
CM0495	4 x 50			50	<b>14,50</b>

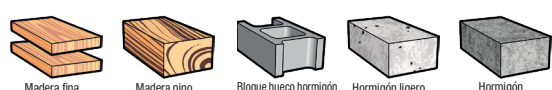

SENDZIMIR GALVANIZED  
 GALVANISÉE SENDZIMIR  
 GALVANIZADO SENDZIMIR



# TIMBER CONNECTORS



RACCORDS POUR BOIS / CONECTORES PARA MADERA / FERRAGENS PARA CONSTRUÇÕES EM MADEIRA

**PLETINA DE UNIÓN, BICROMATADA, ORIFICIOS AVELLANADOS EN AMBAS CARAS**  
FLAT CONNECTOR, WITH BEVELLED-EDGE HOLES ON BOTH SIZES, YELLOW ZINC PLATED  
PLAQUE DE LIASION, BICHROMATÉE, TROUS FRAISES SUR LES 2 FACES  
CHAPA DE UNIÃO, PASS. AMARELO, FURAÇÃO ESCAREADA EM AMBOS OS LADOS

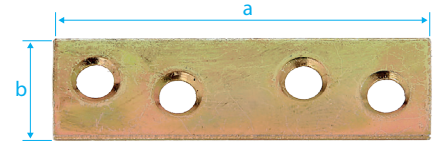
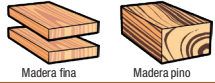
CODE CÓDIGO	SIZES / DIMENSIONS / MEDIDAS a x b		Nº AGUJEROS Nº HOLE / TROUS		€ / 100
CM0500	50 x 14	1,75	4 / 4,50	100	<b>33,96</b>
CM0505	60 x 14	1,75	4 / 4,50	100	<b>38,09</b>
CM0510	80 x 15	1,75	4 / 4,50	100	<b>42,22</b>
CM0515	100 x 15	1,75	4 / 4,50	100	<b>46,69</b>
CM0520	120 x 16	1,75	4 / 5,50	100	<b>51,84</b>



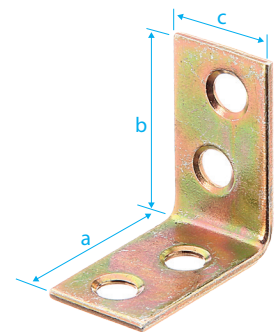
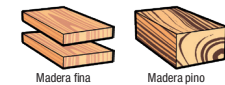

**CORNER BRACES, WITH BEVELLED-EDGE HOLES ON BOTH SIZES, YELLOW ZINC PLATED**  
ÉQUERRE DE CHAISE, BICHROMATÉE, TROUS FRAISÉS SUR LES 2 FACES  
ESCUADRA PARA SILLA BICROMATADA, ORIFICIOS AVELLANADOS EN AMBAS CARAS  
ESQUADRO PARA CADEIRAS PASS. AMARELO, FURAÇÃO ESCAREADA EM AMBOS OS LADOS

CODE CÓDIGO	SIZES / DIMENSIONS / MEDIDAS a x b x c		Nº AGUJEROS Nº HOLE / TROUS		€ / 100
CM0530	25 x 25 x 14	1,75	4 / 4,50	100	<b>27,27</b>
CM0535	30 x 30 x 14	1,75	4 / 4,50	100	<b>34,30</b>
CM0540	40 x 40 x 15	1,75	4 / 4,50	100	<b>38,77</b>
CM0545	50 x 50 x 15	1,75	4 / 4,50	100	<b>43,07</b>
CM0550	60 x 60 x 16	1,75	4 / 5,50	100	<b>47,54</b>
CM0555	75 x 75 x 16	1,75	4 / 5,50	50	<b>60,48</b>
CM0560	90 x 90 x 19	2,00	6 / 5,30	50	<b>77,22</b>
CM0565	100 x 100 x 19	2,00	6 / 5,30	40	<b>90,86</b>
CM0570	125 x 125 x 22	2,00	6 / 6,00	40	<b>140,84</b>
CM0575	150 x 150 x 25	3,00	6 / 6,50	20	<b>204,45</b>



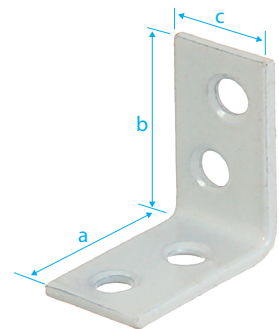
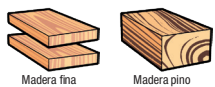

**CORNER BRACES, WITH BEVELLED-EDGE HOLES ON BOTH SIZES, WHITE POWDER COATED**  
ÉQUERRE DE CHAISE, TROUS FRAISÉS SUR LES 2 FACES, PLASTIFICACION BLANCHE  
ESCUADRA PARA SILLA, ORIFICIOS AVELLANADOS EN AMBAS CARAS, PLASTIFICADA BLANCO  
ESQUADRO PARA CADEIRAS, FURAÇÃO ESCAREADA EM AMBOS OS LADOS, PLASTIFICADO A BRANCO

CODE CÓDIGO	SIZES / DIMENSIONS / MEDIDAS a x b x c		Nº AGUJEROS Nº HOLE / TROUS		€ / 100
CM0590	40 x 40 x 15	1,75	4 / 4,50	50	<b>70,53</b>
CM0595	60 x 60 x 16	1,75	4 / 5,50	50	<b>88,64</b>



**CORNER BRACES, TIED WITH CABLE TIE**  
ÉQUERRE DE CHAISE, BICHROMATÉE, MAXIPACK (RELIÉES ENTRE ELLES PAR UN CABLE PLASTIQUE)  
ESCUADRA PARA SILLA BICROMATADA, (UNIDAS POR UNA BRIDA DE NYLON)  
ESQUADRO PARA CADEIRAS PASS. AMARELO, (CONJUNTO EMBALADO ABRAÇADEIRA NYLON)

CODE CÓDIGO	SIZES / DIMENSIONS / MEDIDAS a x b x c		Nº AGUJEROS Nº HOLE / TROUS		€ / KIT
CM0610	25 x 25 x 14 / <b>12 Un.</b>	1,75	4 / 4,50	10	<b>2,66</b>
CM0615	30 x 30 x 14 / <b>12 Un.</b>	1,75	4 / 4,50	10	<b>3,00</b>
CM0620	40 x 40 x 15 / <b>12 Un.</b>	1,75	4 / 4,50	10	<b>3,46</b>
CM0625	50 x 50 x 15 / <b>12 Un.</b>	1,75	4 / 4,50	10	<b>4,19</b>
CM0630	60 x 60 x 16 / <b>8 Un.</b>	1,75	4 / 5,50	10	<b>3,92</b>
CM0635	75 x 75 x 16 / <b>8 Un.</b>	1,75	4 / 5,50	10	<b>4,94</b>

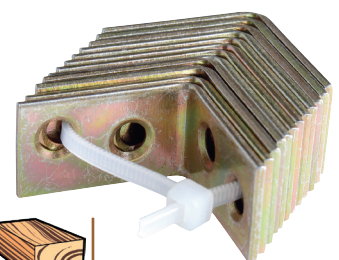
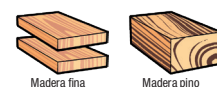

### ANGLED BRACKET, LARGE, EQUAL-SIDED, YELLOW ZINC PLATED

ÉQUERRE LARGE, ÉGALE, BICHROMATÉE  
 ESCUADRA GRANDE DE CARAS IGUALES, BICROMATADA  
 ESQUADRO GRANDE DE LADOS SIMÉTRICO, PASS. AMARELO

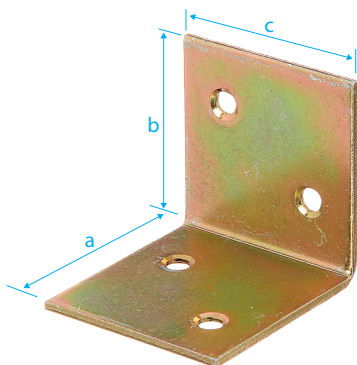

CODE CÓDIGO	SIZES / DIMENSIONS / MEDIDAS a x b x c		Nº AGUJEROS Nº HOLE / TROUS		€ / 100
CM0650	30 x 30 x 30	2,00	4 / 5,00	100	51,84
CM0655	40 x 40 x 40	2,00	4 / 5,00	50	63,61
CM0660	60 x 60 x 60	2,00	8 / 5,00	50	131,74

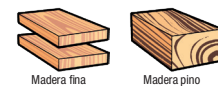

### ANGLED BRACKET, LARGE, EQUAL-SIDED, BROWN POWER COATED

ÉQUERRE LARGE, ÉGALE, PLASTIFIÉE BRUN  
 ESCUADRA GRANDE DE CARAS IGUALES, PLASTIFICADA MARRÓN  
 ESQUADRO GRANDE DE LADOS SIMÉTRICOS, PLASTIFICADO A CASTANHO

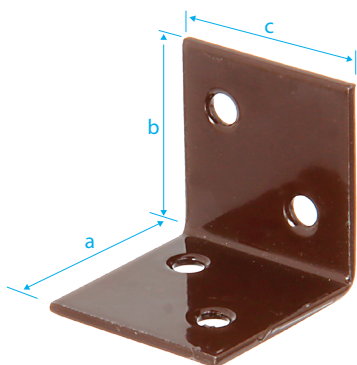

CODE CÓDIGO	SIZES / DIMENSIONS / MEDIDAS a x b x c		Nº AGUJEROS Nº HOLE / TROUS		€ / 100
CM0670	30 x 30 x 30	2,00	4 / 5,00	50	133,68
CM0675	40 x 40 x 40	2,00	4 / 5,00	50	183,46
CM0680	60 x 60 x 60	2,00	8 / 5,00	50	250,64

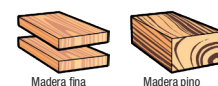

### ANGLED BRACKET, LARGE, EQUAL-SIDED, WHITE POWER COATED

ÉQUERRE LARGE, ÉGALE, PLASTIFIÉE BLANCHE  
 ESCUADRA GRANDE DE CARAS IGUALES, PLASTIFICADA BLANCA  
 ESQUADRO GRANDE DE LADOS SIMÉTRICOS, PLASTIFICADO A BRANCO

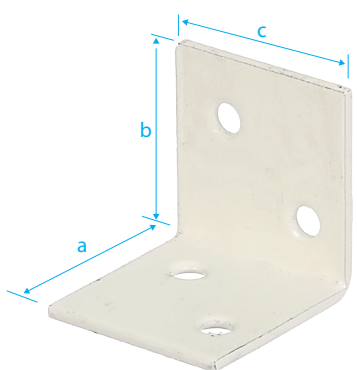

CODE CÓDIGO	SIZES / DIMENSIONS / MEDIDAS a x b x c		Nº AGUJEROS Nº HOLE / TROUS		€ / 100
CM0690	30 x 30 x 30	2,00	4 / 5,00	50	131,90
CM0695	40 x 40 x 40	2,00	4 / 5,00	50	180,03

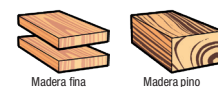

### ANGLED BRACKET LARGE, UNEQUAL-SIDED, YELLOW ZINC PLATED

ÉQUERRE LARGE, INÉGALE, BICHROMATÉE  
 ESCUADRA GRANDE DE CARAS DESIGUALES, BICROMATADA  
 ESQUADRO GRANDE DE LADOS ASIMÉTRICOS, PASS. AMARELO

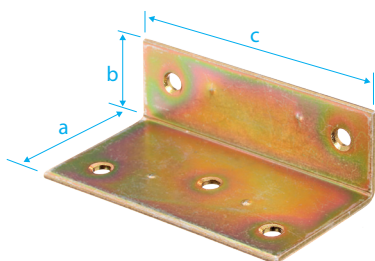

CODE CÓDIGO	SIZES / DIMENSIONS / MEDIDAS a x b x c		Nº AGUJEROS Nº HOLE / TROUS		€ / 100
CM0700	40 x 25 x 75	2,00	5 / 4,80	50	140,19

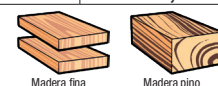



# TIMBER CONNECTORS

RACCORDS POUR BOIS / CONECTORES PARA MADERA / FERRAGENS PARA CONSTRUÇÕES EM MADEIRA

## FLAT CONNECTOR, T-SHAPED, SENDZIMIR GALVANIZED

PLATINE EN "T", GALVANISÉE SENDZIMIR  
PLETINA EN "T", GALVANIZADA SENDZIMIR  
CHAPA EM "T", GALVANIZADO SENDZIMIR

CODE CÓDIGO	SIZES / DIMENSIONS / MEDIDAS a x b x c		Nº AGUJEROS Nº HOLE / TROUS		€ / 100
CM0710	50 x 70 x 16	2,00	6 / 3,80	50	<b>58,61</b>
CM0715	110 x 140 x 30	2,00	6 / 5,00	25	<b>168,99</b>

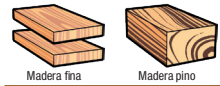

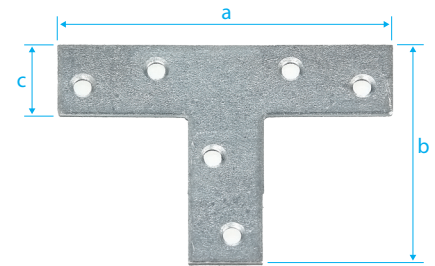

SENDZIMIR GALVANIZED  
GALVANISÉE SENDZIMIR  
GALVANIZADO SENDZIMIR



## ADJUSTABLE CONNECTOR, YELLOW ZINC PLATED

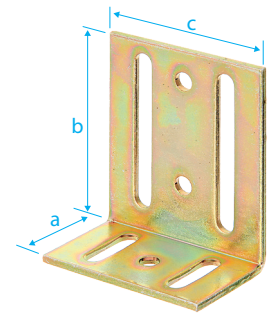
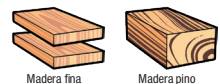

ÉQUERRE RÉGLABLE BICHROMATÉE  
ESCUADRA REGULABLE, BICROMATADA  
ESQUADRO REGULÁVEL, PASS. AMARELO

CODE CÓDIGO	SIZES / DIMENSIONS / MEDIDAS a x b x c		Nº AGUJEROS Nº HOLE / TROUS		€ / 100
CM0720	40 x 77 x 65	3,00	3/7 - 2/7x60 - 2/7x25	25	<b>257,01</b>



## JOIST HANGER CONNECTOR, UNEQUAL-SIDED, YELLOW ZINC PLATED

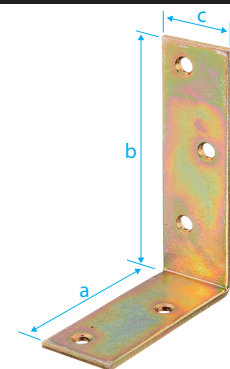
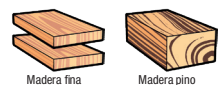

ÉQUERRE À POUTRE INÉGALE, BICHROMATÉE  
ESCUADRA PARA POSTE DE CARAS DESIGUALES, BICROMATADA  
ESQUADRO PARA POSTE COM LADOS ASIMÉTRICOS, PASS. AMARELO

CODE CÓDIGO	SIZES / DIMENSIONS / MEDIDAS a x b x c		Nº AGUJEROS Nº HOLE / TROUS		€ / 100
CM0730	75 x 100 x 30	3,00	5 / 5,50	50	<b>145,39</b>
CM0735	80 x 120 x 35	4,00	7 / 7,00	25	<b>249,86</b>



## ADJUSTABLE CONNECTOR, YELLOW ZINC PLATED

ÉQUERRE EMBOUTIE RÉGLABLE BICHROMATÉE  
ESCUADRA PARA EMPOTRAR REGULABLE, BICROMATADA  
ESQUADRO PARA ENCASTRAR REGULÁVEL, PASS. AMARELO

CODE CÓDIGO	SIZES / DIMENSIONS / MEDIDAS a x b x c		Nº AGUJEROS Nº HOLE / TROUS		€ / 100
CM0740	25 x 25 x 30	1,25	1/5,00x15 - 2/5,00	50	<b>63,62</b>

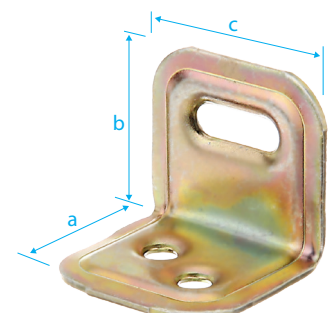

### ADJUSTABLE CONNECTOR, YELLOW ZINC PLATED

ÉQUERRE EMBOUTIE RÉGLABLE BICHROMATÉE  
 ESCUADRA PARA EMPOTRAR REGULABLE, BICROMATADA  
 ESQUADRO PARA ENCASTRAR REGULÁVEL, PASS. AMARELO

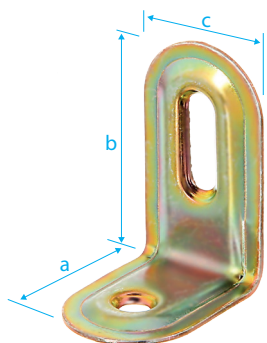

CODE CÓDIGO	SIZES / DIMENSIONS / MEDIDAS a x b x c		Nº AGUJEROS Nº HOLE / TROUS		€ / 100
CM0750	28 x 40 x 22	1,00	1/4,50x16 - 1/4,50	50	56,21

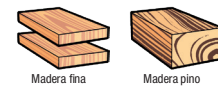

### WIDE ANGLE ADJUSTABLE CONNECTOR TO BE EMBEDDED, YELLOW ZINC PLATED

ÉQUERRE LARGE EMBOUTIE RÉGLABLE, BICHROMATÉE  
 ESCUADRA GRANDE PARA EMPOTRAR REGULABLE, BICROMATADA  
 ESQUADRO PARA ENCASTAR GRANDE REGULÁVEL, PASS. AMARELO

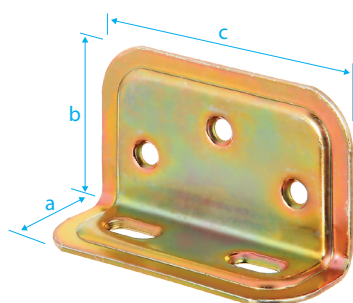

CODE CÓDIGO	SIZES / DIMENSIONS / MEDIDAS a x b x c		Nº AGUJEROS Nº HOLE / TROUS		€ / 100
CM0760	25 x 40 x 70	1,50	2/5,0x12 - 3/5,0	20	118,11

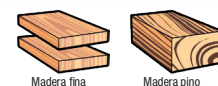

### SUPPORTING CORNER BRACE, TO BE EMBEDDED, YELLOW ZINC PLATED

ÉQUERRE EMBOUTIE, BICHROMATÉE  
 ESCUADRA PARA EMPOTRAR, BICROMATADA  
 ESQUADRO PARA ENCASTRAR, PASS. AMARELO

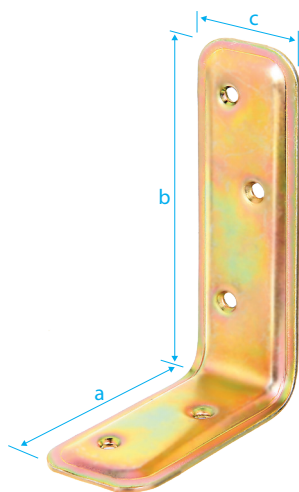

CODE CÓDIGO	SIZES / DIMENSIONS / MEDIDAS a x b x c		Nº AGUJEROS Nº HOLE / TROUS		€ / 100
CM0770	80 x 120 x 40	2,00	5 / 4,50	20	205,17
CM0775	100 x 160 x 40	2,00	5 / 4,50	20	281,06

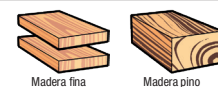

### FLAT CONNECTOR, TO BE EMBEDDED, YELLOW ZINC PLATED

PLATINE EMBOUTIE BICHROMATÉE  
 PLETINA PARA EMPOTRAR, BICROMATADA  
 CHAPA PARA ENCASTRAR, PASS. AMARELO

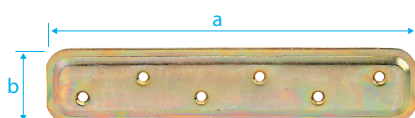

CODE CÓDIGO	SIZES / DIMENSIONS / MEDIDAS a x b		Nº AGUJEROS Nº HOLE / TROUS		€ / 100
CM0780	180 x 40	2,00	6 / 4,50	20	195,89

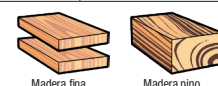



# TIMBER CONNECTORS

RACCORDS POUR BOIS / CONECTORES PARA MADERA / FERRAGENS PARA CONSTRUÇÕES EM MADEIRA

## DECORATIVE CORNER BRACE, WHITE POWER COATED

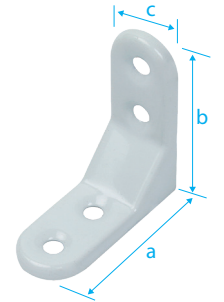
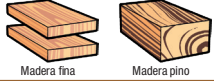

ÉQUERRE DE CHAISE RENFORCÉE, PLASTIFIÉE BLANCHE  
ESCUADRA DE SILLA EMBUTIDA, PLASTIFICADA BLANCA  
ESQUADRO DE CADEIRA PARA FACEAR, PLASTIFICADO A BRANCO

CODE CÓDIGO	SIZES / DIMENSIONS / MEDIDAS a x b x c		Nº AGUJEROS Nº HOLE / TROUS		€ / 100
CM0790	30 x 30 x 20	1,00	2 / 5,30	20	<b>117,15</b>
CM0795	50 x 50 x 20	1,00	4 / 5,30	20	<b>161,72</b>
CM0800	75 x 75 x 20	1,00	4 / 5,30	10	<b>174,95</b>
CM0805	103 x 103 x 21	2,00	6 / 5,00	10	<b>266,31</b>
CM0810	130 x 130 x 21	1,50	6 / 5,00	10	<b>349,05</b>



## DECORATIVE CORNER BRACE, GREY-ALUMINIUM POWER COATED

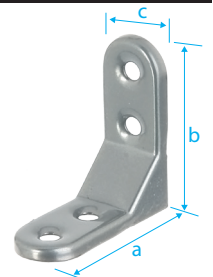
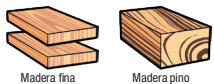

ÉQUERRE DE CHAISE RENFORCÉE, PLASTIFIÉE GRIS ALUMINIUM  
ESCUADRA DE SILLA EMBUTIDA, PLASTIFICADA GRIS ALUMINIUM  
ESQUADRO DE CADEIRA PARA FACEAR, PLASTIFICADO A CINZA ALUMINIUM

CODE CÓDIGO	SIZES / DIMENSIONS / MEDIDAS a x b x c		Nº AGUJEROS Nº HOLE / TROUS		€ / 100
CM0820	50 x 50 x 20	1,00	4 / 5,30	20	<b>162,28</b>
CM0825	75 x 75 x 20	1,00	4 / 5,30	10	<b>174,95</b>
CM0830	103 x 103 x 21	2,00	6 / 5,00	10	<b>266,31</b>
CM0835	130 x 130 x 21	1,50	6 / 5,00	10	<b>349,05</b>



## ANGLED BRACKET FOR FURNITURE, ZINC PLATED

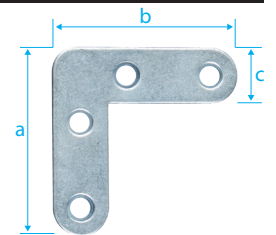
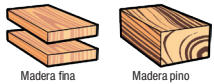

ÉQUERRE POUR MEUBLES, ZINGUÉE  
ESCUADRA PARA MUEBLES CON EXTREMIDADES REDONDAS, ZINCADO  
ESQUADRO PARA MÓVEIS COM EXTREMIDADES ARRENDADAS, ZINCADO

CODE CÓDIGO	SIZES / DIMENSIONS / MEDIDAS a x b x c		Nº AGUJEROS Nº HOLE / TROUS		€ / 100
CM0845	40 x 40 x 12	1,75	4 / 5,30	100	<b>21,19</b>



## CORNER BRACES, REINFORCED, ZINC PLATED

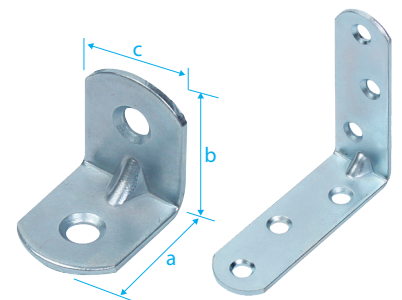
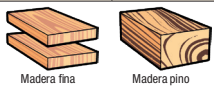

ÉQUERRE DE CHAISE RENFORCÉE, ZINGUÉE  
ESCUADRA DE SILLA REFORZADA, ZINCADA  
ESQUADRO PARA CADEIRA REFORÇADO, ZINCADO

CODE CÓDIGO	SIZES / DIMENSIONS / MEDIDAS a x b x c		Nº AGUJEROS Nº HOLE / TROUS		€ / 100
CM0860	20 x 20 x 16	1,75	2 / 4,50	120	<b>17,03</b>
CM0865	30 x 30 x 16	1,75	4 / 4,20	120	<b>21,56</b>
CM0870	40 x 40 x 19	1,75	4 / 4,70	120	<b>35,52</b>
CM0875	60 x 60 x 19	1,75	6 / 5,20	120	<b>57,41</b>
CM0880	80 x 80 x 19	1,75	6 / 5,50	50	<b>75,40</b>
CM0885	100 x 100 x 19	1,75	6 / 5,00	50	<b>81,61</b>



## FLAT CONNECTOR, ZINC PLATED

PLAQUE DE LIASION, ZINGUÉE  
PLETINA DE ENSAMBLAJE, ZINCADA  
CHAPA DE MONTAGEM, ZINCADO

CODE CÓDIGO	SIZES / DIMENSIONS / MEDIDAS a x b		Nº AGUJEROS Nº HOLE / TROUS		€ / 100
CM0900	16 x 40	1,50	2 / 4,50	100	<b>21,38</b>
CM0905	16 x 60	1,50	4 / 4,00	100	<b>25,72</b>
CM0910	19 x 80	2,00	4 / 4,50	100	<b>39,68</b>

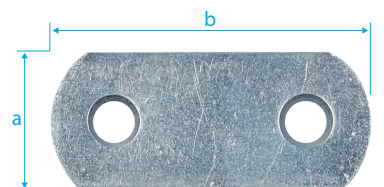
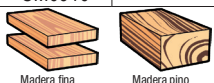

A series of horizontal dashed lines for writing notes, spanning the width of the page.

A series of horizontal dashed lines for writing notes.

A series of horizontal dashed lines for writing notes.

A series of horizontal dashed lines for writing notes.

A series of horizontal dashed lines for writing notes.

A series of horizontal dashed lines for writing notes.



European Import Group

[www.eig.pt](http://www.eig.pt)